

SEIKO

DIGITAL QUARTZ

Cal. 0138A

PARTS LIST

Cal. 0138A

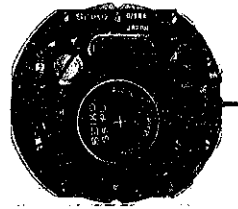
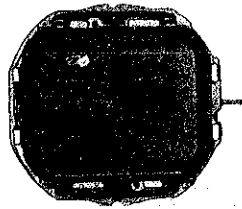

354 054



383 035



389 004



637 005



735 003

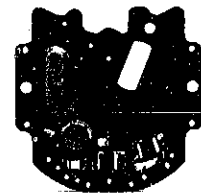

4001 096

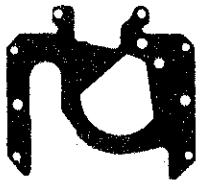

4216 042



4242 055



4242 065



4245 015



4270 015



4299 018



4313 019



4398 017

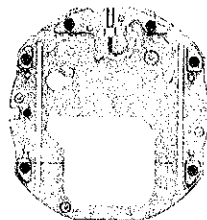

4398 042



4408 015



4450 004



4450 008

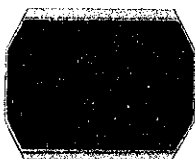

4510 304

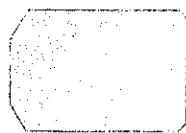

4521 018



4530 006



4532 001

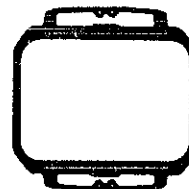

4540 005



☆ SEIKO SB-BU

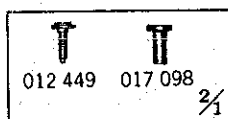

012 449 017 098

2/1

Cal. 0138A

Characteristics

Casing diameter : ϕ 29.20 mm
 Maximum height : 6.16 mm without battery
 Frequency of quartz crystal oscillator : 32,768 Hz (Hz=Hertz Cycles per second)
 Time functions : Digital Display System showing hour, minute, second and day.
 Stopwatch functions : 20-hour Digital Display System showing hour, minute, second, 1/100 second and LAP-STOP indication.
 Countdown functions : Hours, minutes and seconds can be counted down. The desired amount of time is set (up to 19 hours and 59 minutes).
 Calendar functions : Digital Display System showing day and date.
 Display medium : Single Crystal Display (Nematic Liquid Crystal, FE-Mode)
 Time micro-adjustor : Trimmer condenser system
 Illumination light for digital display panel : Illuminated in accordance with the button depressing.
 Battery life indicator All the digits of the time and calendar function begin flashing.

PART NO.	PART NAME	PART NO.	PART NAME
354 054	Switch button stem		
383 035	Setting lever		
389 004	Setting lever holder		
637 005	Contact point spring		
735 003	Switch button stem holder		
4001 096	Circuit block		
4216 042	Insulator for circuit		
4242 055	Plus terminal of battery connection (A)		
4242 065	Plus terminal of battery connection (B)		
4245 015	Switch spring		
4270 015	Battery connection		
4299 018	Lower plate for switch components		
4313 019	Connector		
4398 017	Battery guard		
4398 042	Liquid crystal panel frame		
4408 015	Bulb holder		
4450 004	Switch lever (A)		
4450 008	Switch lever (B)		
4510 304	Liquid crystal panel		
4521 018	Reflecting mirror		
4530 006	Bulb		
4532 001	Bulb holder cover		
4540 005	Spring for liquid crystal panel		
012 449	Setting lever holder screw		
012 449	Bulb holder cover screw		
012 449	Screw for plus terminal of battery connection (A)		
012 449	Screw for battery connection		
017 098	Tube for battery connection screw		
☆SEIKO SB-BU ☆Maxell SR1130W	} Silver oxide battery		

Remarks :

☆Battery.....The applied battery for this calibre might be added the substitutive in the future. In that case, please refer to separate "BATTERIES FOR SEIKO QUARTZ WATCHES".

☆⇨Please see remarks.

Part numbers in light letters are not shown in photos.

TECHNICAL GUIDE

SEIKO

DIGITAL QUARTZ

CAL. 0138A



CONTENTS

	<i>Page</i>
I. SPECIFICATIONS AND FEATURES	1
1. Specifications	1
2. Features	1
II. BUTTON OPERATION AND TIME SETTING	2
1. How to change the displays	2
2. How to set the time and calendar	2
3. How to use the stopwatch	4
4. How to use the countdown function	5
5. Battery life indicator	7
III. AFTER-SALE SERVICING INSTRUMENTS AND MATERIALS	8
IV. DISASSEMBLING AND REASSEMBLING OF THE CASE	9
V. DISASSEMBLING, REASSEMBLING, LUBRICATING AND CLEANING	11
1. Liquid crystal panel side	11
2. Switch mechanism side	13
3. Cleaning	15
VI. CHECKING AND ADJUSTMENT	16
1. Guide table for checking and adjustment	16
2. Malfunction and checking points	17
3. Relationship between the segment (Liquid Crystal Panel Electrode) and the C-MOS-LSI output terminal	18
4. Procedures for checking and adjustment	19
A: Check battery voltage	19
B: Check battery conductivity	19
C: Check conductivity of liquid crystal panel, circuit block and connector	20
D: Check circuit block and liquid crystal panel	20
E: Check current consumption	22
F: Check accuracy	22
G: Check switch components	23
H: Check battery life indicator	24
I: Check bulb condition	24
J: Check functioning and adjustment	25

Calibre 0138A

Calibre 0138A

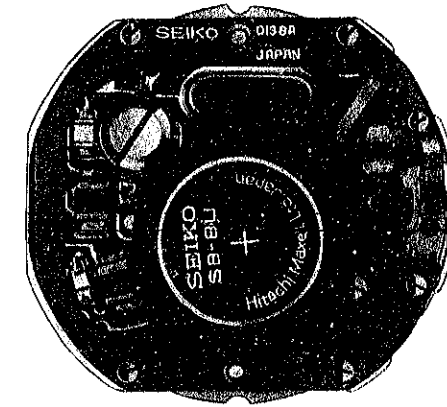
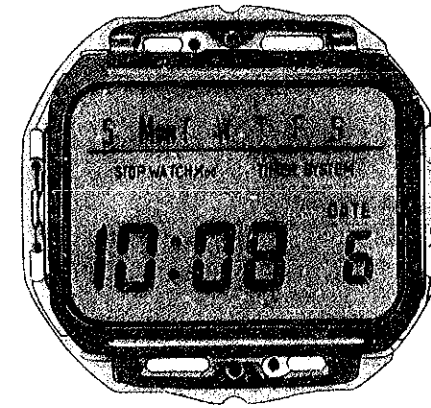

Module

I. SPECIFICATIONS AND FEATURES

1. Specifications

Item	Calibre No. 0138A
Display medium	Nematic Liquid Crystal, FEM (Field Effect Mode)
Display system	Three-display changeover system with the time and calendar display, the stopwatch display and the countdown display. <ul style="list-style-type: none"> • Time and calendar display <ul style="list-style-type: none"> Hour, Minute and Second: 12-hour Digital Display System Date: Automatic calendar system (Automatically adjusts for even and odd months except February of leap years.) Day: Displayed in English (The second digits and the date digits are selected as desired by depressing button "B".) • Stopwatch display (Accumulate time up to 20 hours.) <ul style="list-style-type: none"> Digital display system showing hour, minute, second and hundredths of a second with "LAP" mark. • Countdown display (The desired amount of time can be set up to 19 hours and 59 minutes.) <ul style="list-style-type: none"> Digital display system showing hour, minute and second.
Additional mechanism	Battery life indicator Illuminating light
Crystal oscillator	32,768 Hz (Hz = Hertz . . . Cycles per second)
Loss/gain	Loss/gain at normal temperature range Mean monthly rate: less than 10 seconds Annual rate: less than 2 minutes
Casing diameter	φ 29.2 mm (25.3 mm between 6 o'clock and 12 o'clock sides; 28.5 mm between 3 o'clock and 9 o'clock sides)
Height	6.1 mm without battery
Operational temperature range	-10°C ~ +60°C (14°F ~ 140°F)
Regulation system	Trimmer condenser
Battery power	Silver oxide battery SEIKO SB-BU or Maxell SR-1130W Battery life is approximately two years.
IC (Integrated Circuit)	C-MOS-LSI . . . 1 unit

2. Features

- (1) The "hour", "minute", "second", "date" and "day", all of which are most frequently referred to in daily use, are displayed together on the display panel. (The second digits and the date digits are selected as desired.)
- (2) It has an automatic calendar system, and therefore even and odd months except February of leap years are automatically adjusted.
- (3) The stopwatch function is capable of measuring down to 1/100 of a second.
- (4) The countdown function enables the watch to count down the desired amount of time, which can be set up to 19 hours and 59 minutes. When all the desired amount of time is elapsed, "0:0000" is displayed and the overtime is counted up. (The counting up is displayed by sweeping digits and thus is distinguished from the counting down.)
- (5) Equipped with a battery life indicator, Cal. 0138A signals the expiration of battery life in advance.
- (6) Illuminating light enables the time and calendar to be read in the dark.

II. BUTTON OPERATION AND TIME SETTING

1. How to change the displays

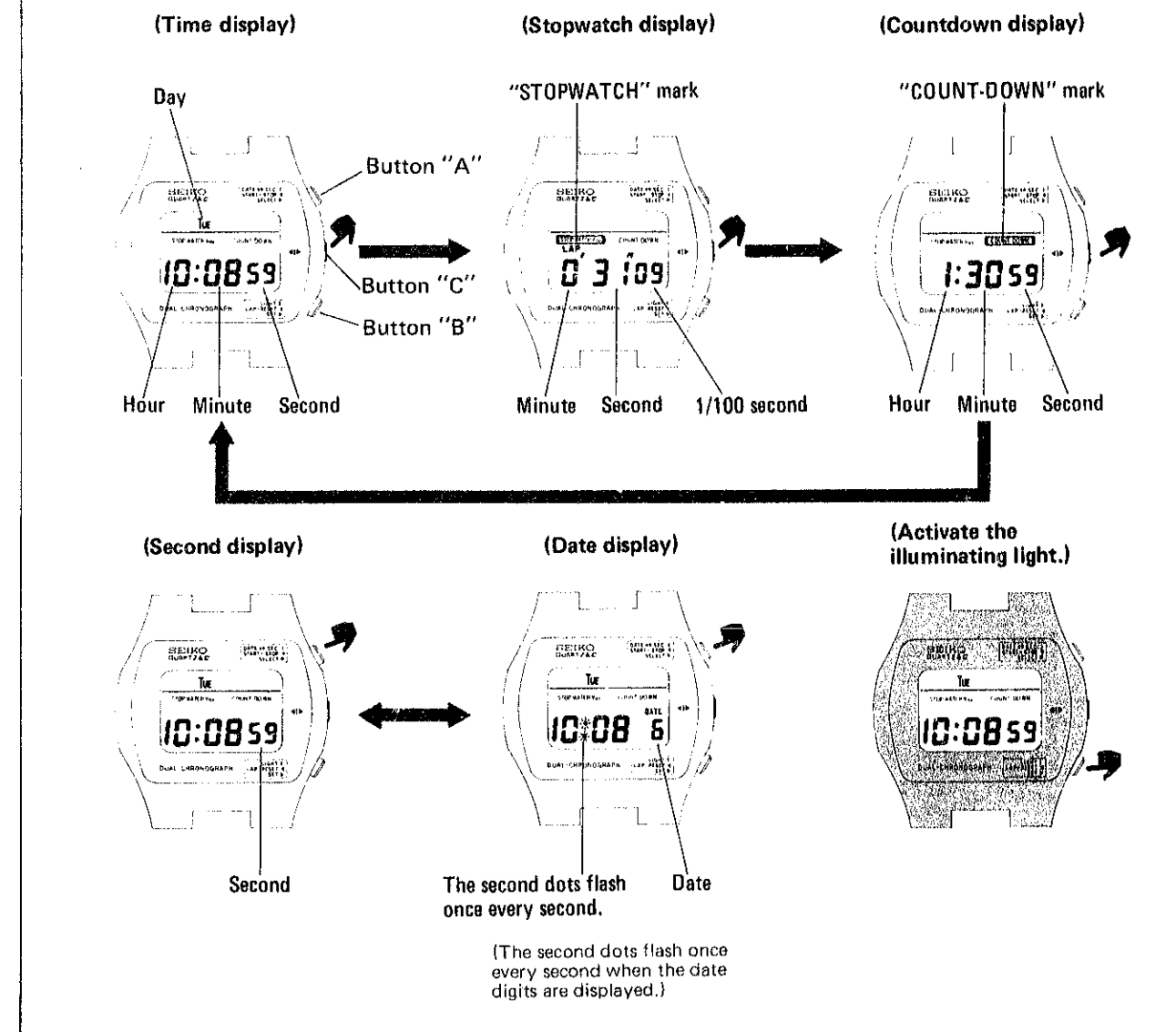

2. How to set the time and calendar





- (1) Pull out button "C" when the time digits are displayed. The time digits (second) are ready to be adjusted.
- (2) Each depression of button "A" selects the digits (flashing twice every second) to be adjusted in the following order.

→ Second → Hour → 10-minute → 1-minute → Month → Date → Day →

- (3) Depress button "A" to select the digits to be adjusted. One digit is advanced by each depression of button "B".

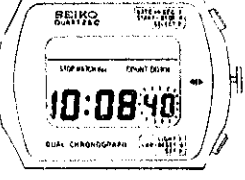
[Example]

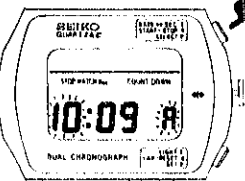
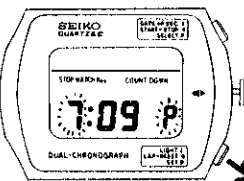
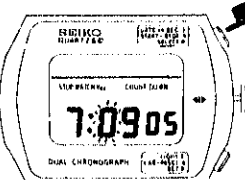
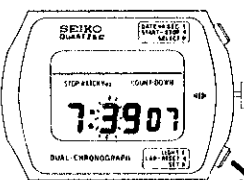
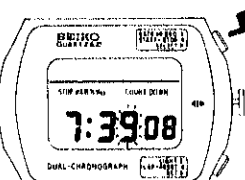
The illustrations show that the indication of Tuesday, October 6, 10:08:40 A.M. is changed into Monday, January 30, 7:30:00 P.M.

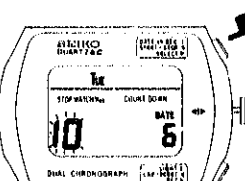
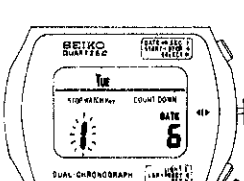
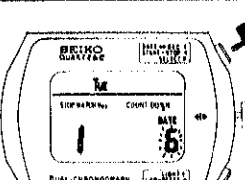
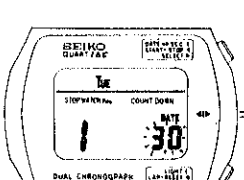
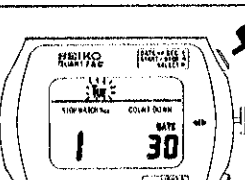
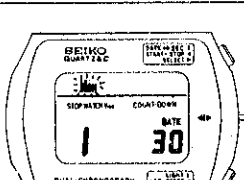
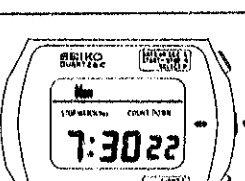
Button Operation (SELECT and SET)		
Digits and mark to be adjusted	SELECT (Selection of the digits to be adjusted)	SET (Set the desired digits)
Second	 <p>Pull out button "C" when the time and calendar digits are displayed. The second digits start flashing. (Even if the date digits are displayed, they will automatically change into the second digits and start flashing when button "C" is pulled out.)</p>	 <p>Depress button "B" (Depress button "B" in accordance with "00" second of a time signal and the seconds are then reset to "00" and start immediately.*)</p>
Hour	 <p>Depress button "A" and the hour digits and "A" (stands for A.M.) or "P" (stands for P.M.) start flashing.</p>	 <p>One digit (hour) is advanced by each depression of button "B". When setting the hours, be sure to check that the hour setting is made with the correct "A" (A.M.) or "P" (P.M.) period appropriately displayed.</p>
Minute (10-minute)	 <p>Depress button "A" and the 10-minute digit starts flashing.</p>	 <p>One digit (10-minute) is advanced by each depression of button "B".</p>
Minute (1-minute)	 <p>Depress button "A" and the 1-minute digit starts flashing.</p>	 <p>One digit (1-minute) is advanced by each depression of button "B".</p>
Month	 <p>Depress button "A" and the month, the date and the day digits are displayed and the month digits starts flashing.</p>	 <p>One digit (month) is advanced by each depression of button "B".</p>
Date	 <p>Depress button "A" and the date digits start flashing.</p>	 <p>One digit (date) is advanced by each depression of button "B".</p>
Day	 <p>Depress button "A" and the day digits start flashing.</p>	 <p>One digit (day) is advanced by each depression of button "B".</p>
End of procedures	 <p>After all adjustments are completed, push button "C" in to the normal position and the time and calendar digits will be automatically displayed. Whichever digits are being adjusted, the time and calendar digits are displayed by pushing button "C" in to the normal position.</p>	

* When the seconds count any numbers from "00" to "29", the seconds are reset to "00" automatically whenever button "B" is depressed. When the seconds count any numbers from "30" to "59" and button "B" is depressed, one minute is added and the seconds are immediately reset to "00".

3. How to use the stopwatch (Accumulation)

(1) Stopwatch display

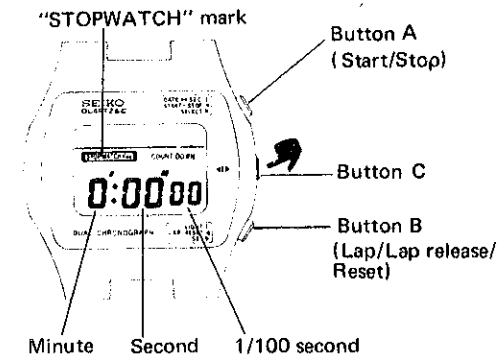

Push button "C" once when the time and calendar digits are displayed. The time and calendar display is changed into the stopwatch display and the square around "STOPWATCH" mark appears.

* "STOPWATCH" mark square

- The stopwatch is not used . . . It appears but does not flash.
- The stopwatch is used . . . It appears and starts flashing once every second.
- The time and calendar digits or the countdown digits are displayed while the stopwatch is used. . . It appears and starts flashing once every five seconds.

[Counting covers less than 20 minutes]

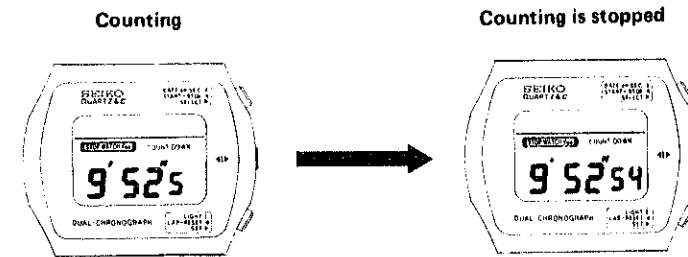

Down to 1/10 of a second is displayed while less than 20 minutes are counted.

[Counting passes 20 minutes]

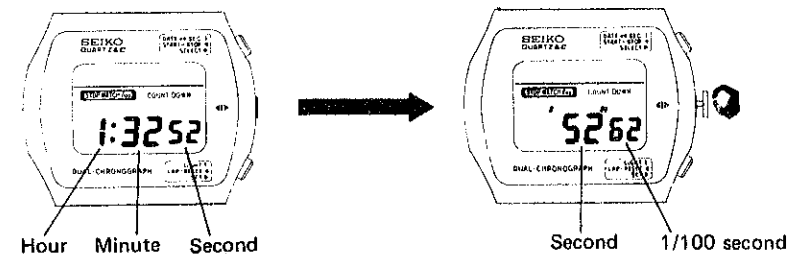

Down to a second is displayed while more than 20 minutes are counted and when the counting is stopped.

Down to 1/100 of a second is displayed when the counting is stopped within 20 minutes or even when the counting is stopped for lap time measurement within 20 minutes.

Down to 1/100 of a second is displayed by pulling button "C" out while more than 20 minutes are counted or when the counting is stopped.

(2) How to count

1. Preparation

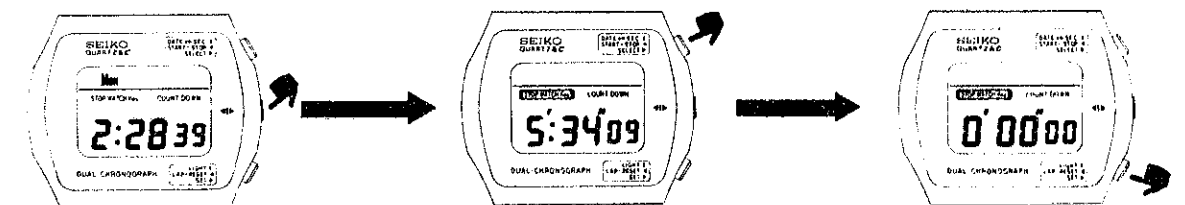

Push button "C" when the time and calendar digits are displayed. The time and calendar display is changed into the stopwatch display.

If the stopwatch is counting, depress button "A" once or twice and the counting is stopped.

Depress button "B" and the digits are then reset to "0:00:00" and counting is ready to be started.

2. Elapsed time measurement (Start/Stop)

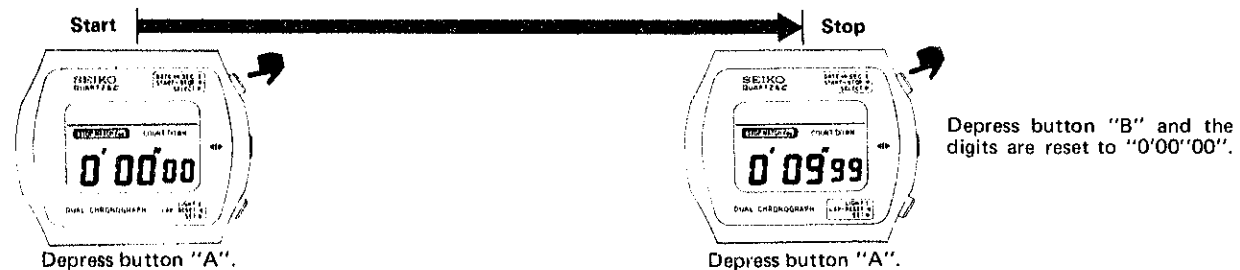

3. Lap time measurement

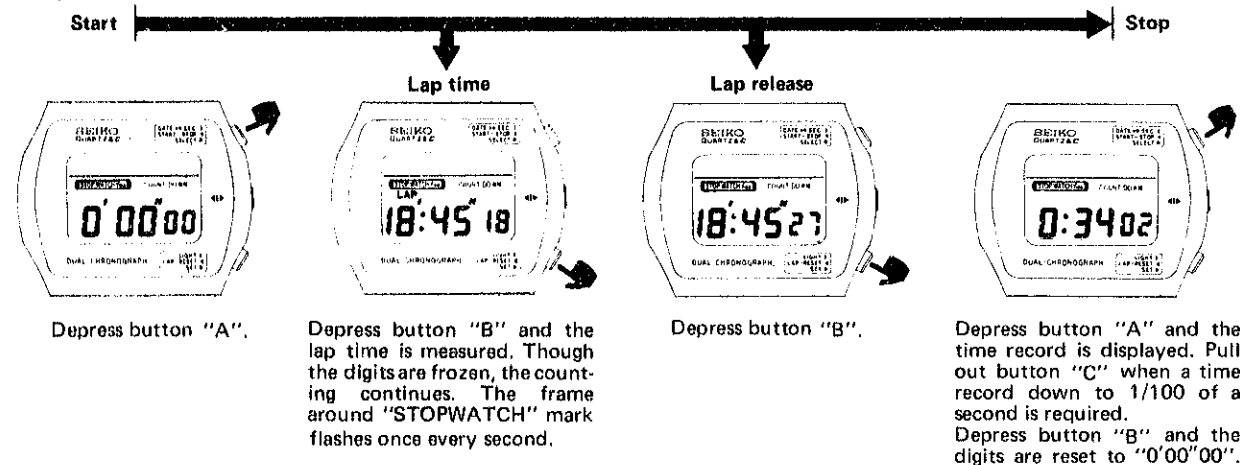

4. Continuous time measurement of two competitors

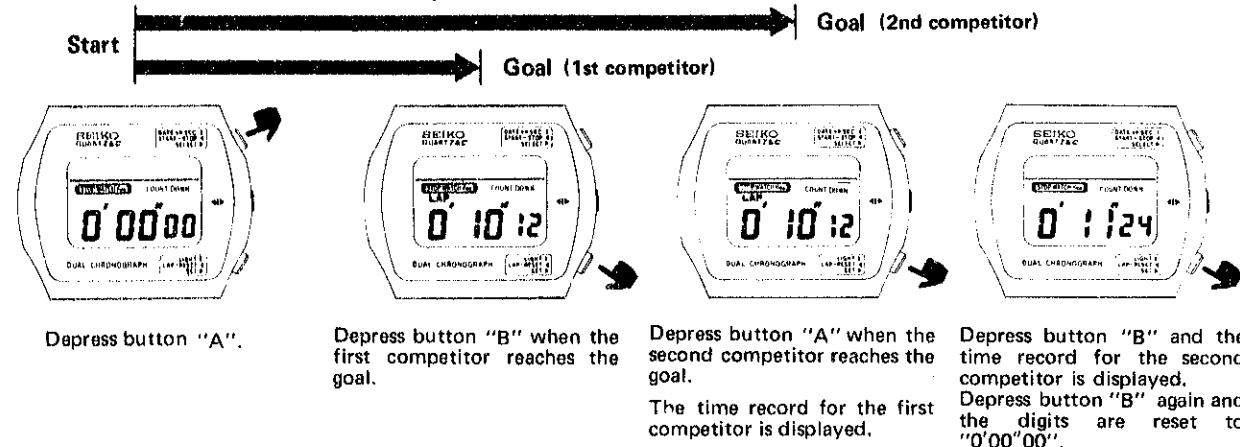

4. How to use the countdown function

(1) Countdown display

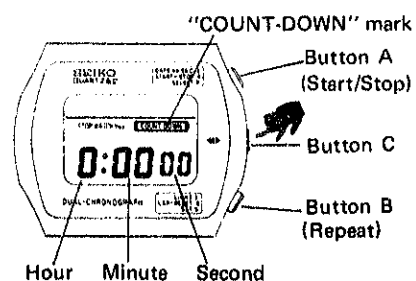

Push button "C" twice when the time and calendar digits are displayed. The time and calendar display is changed into the countdown display and the square around "COUNT-DOWN" mark appears.

* "COUNT-DOWN" mark square

- The countdown function is not used . . . It appears but does not flash.
- The countdown function is used . . . It appears and starts flashing once every second.
- The time and calendar digits or the stopwatch digits are displayed while the countdown function is used . . . It appears and starts flashing once every five seconds.

(2) How to count down

1. Preparation

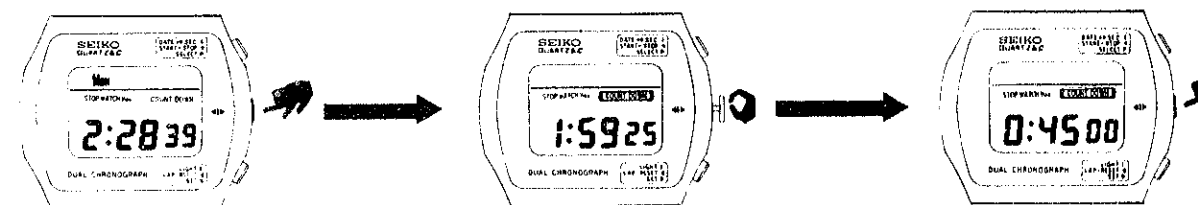

Push button "C" twice when the time and calendar or seconds digits are displayed. The time and calendar or seconds display is changed into the countdown display.

Pull out button "C" and set the desired amount of time to be counted down.

After the desired amount of time is set, push button "C" into the normal position.

* How to set the desired amount of time

Pull out button "C" when the countdown digits are displayed. The time previously set is displayed and the hour digit starts flashing.

Each depression of button "A" selects the digits to be adjusted in the following order.



Up to 19 hours and 59 minutes can be counted down.

Refer to "How to set the time and calendar" for setting the desired amount of time to be elapsed.

2. How to count down the desired amount of time

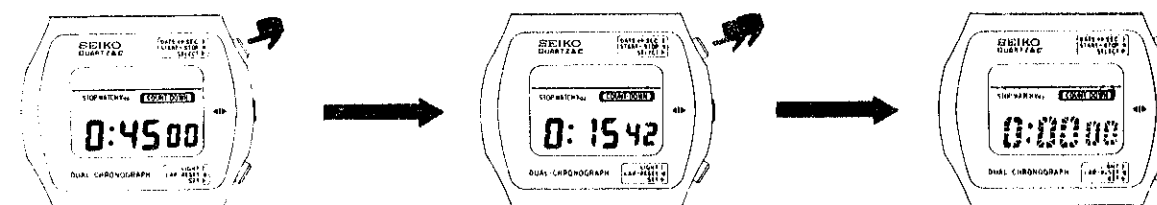

Depress button "A" and the counting down is started.

Depress button "A" while the desired amount of time is counted down and the counting down is stopped. Depress button "A" again and the counting down is restarted.

When all the desired amount of time is elapsed, "0:00:00" is displayed in sweeping digits and the overtime is counted up.

3. How to repeat the counting down from the start

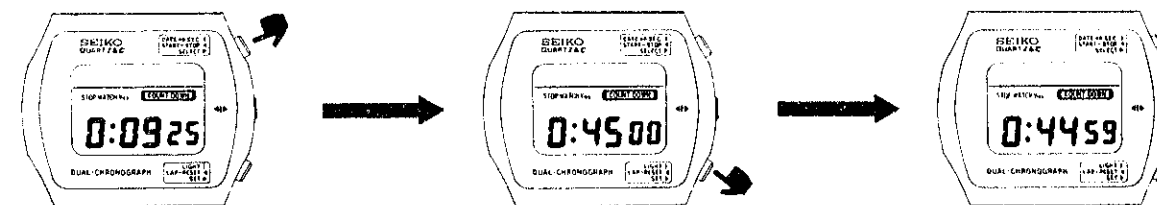

Depress button "A" and the counting down (or up) is stopped.

Depress button "B" and the desired amount of time to be counted down is displayed again.

Depress button "A" and the counting down will be repeated from the start.

(3) How to count up the elapsing time in the countdown function

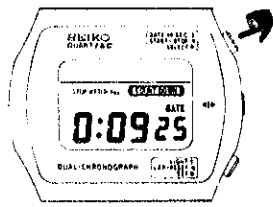

Depress button "A" and the counting down is stopped.

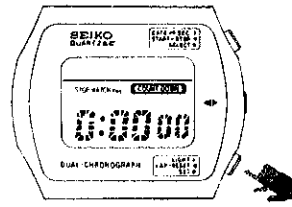

Depress button "B" twice and "0:0000" will be displayed in sweeping digits.

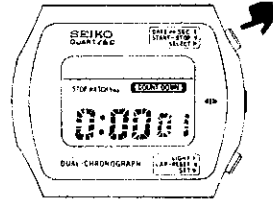

Depress button "A" and the counting up will be started by the sweeping digits. (Functions as an extra-stopwatch)

5. Battery life indicator

The battery life indicator starts the time and calendar display flashing every second when the battery life is coming to its end. However, the watch will remain accurate while the entire display is flashing.

III. AFTER-SALE SERVICING INSTRUMENTS AND MATERIALS

For after-sale servicing of SEIKO Quartz Digital Cal. 0138A, the following instruments and materials are necessary.

1. Quartz Tester

Used to check time accuracy (daily rate).

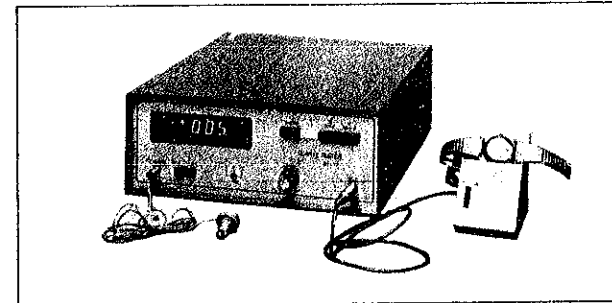

2. Micro Test MT-10II

Used to check current consumption and to supply constant voltage power.

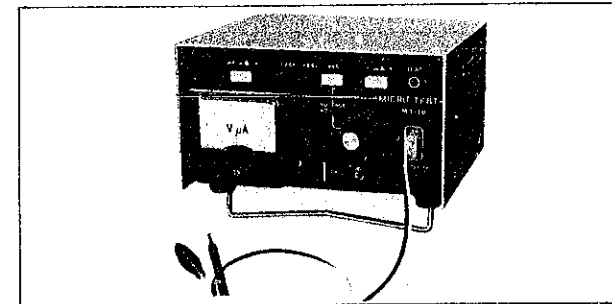

3. Volt-ohm-meter (S-831)

Used to check battery voltage and measure current consumption, etc.

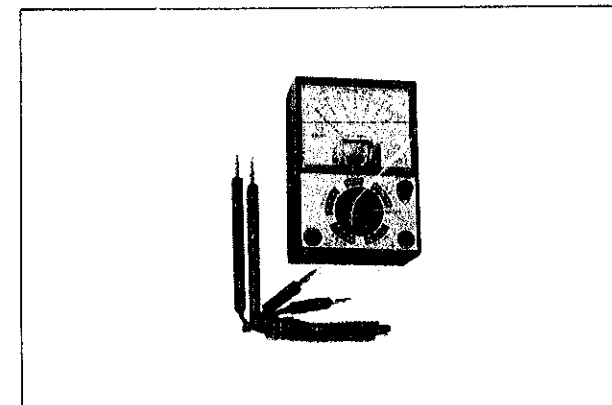

4. Static electricity protector (S-830)

Used to protect the C-MOS-LSI of Digital Quartz from being damaged by static electricity.

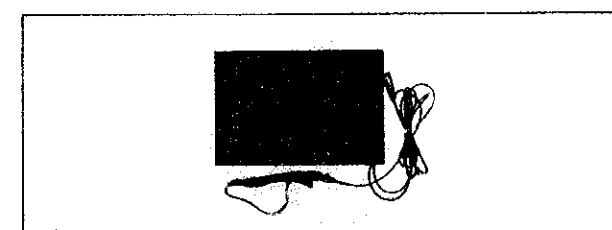

5. Movement holder (S-644)

Used for disassembling and reassembling of the module.

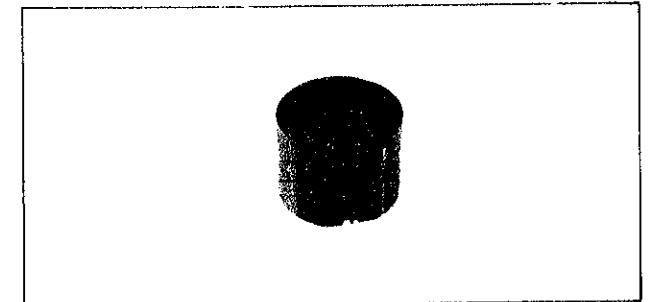

6. Battery holding spring (S-812)

Used for securing battery and flowing current when the module is removed from the case.

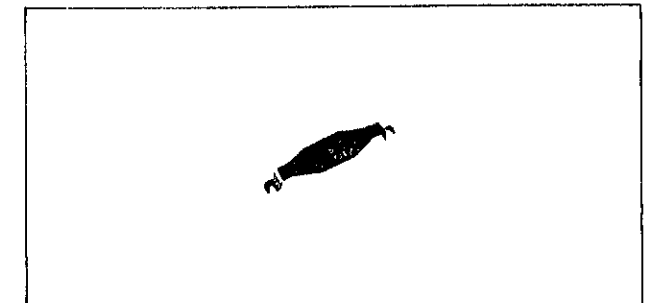

7. Inserting disk (S-161)

Used to disassemble the glass from the casebezel.

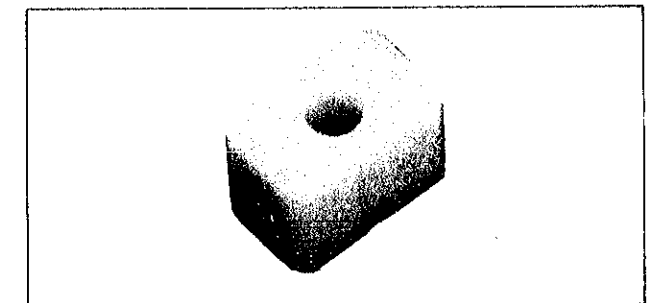

8. Plastic supporting disk (S-173)

Used to reassemble the glass in the casebezel.

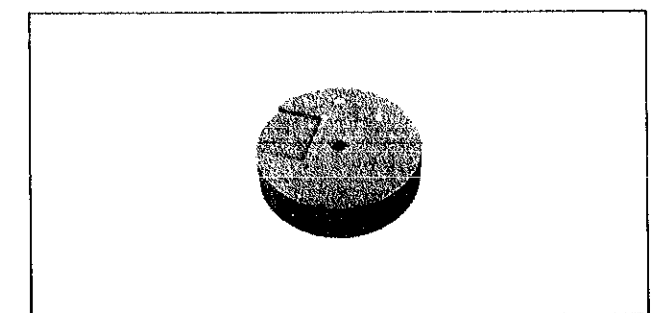

IV. DISASSEMBLING AND REASSEMBLING OF THE CASE

Lubricating  : Silicon grease 500,000 c.s., normal quantity

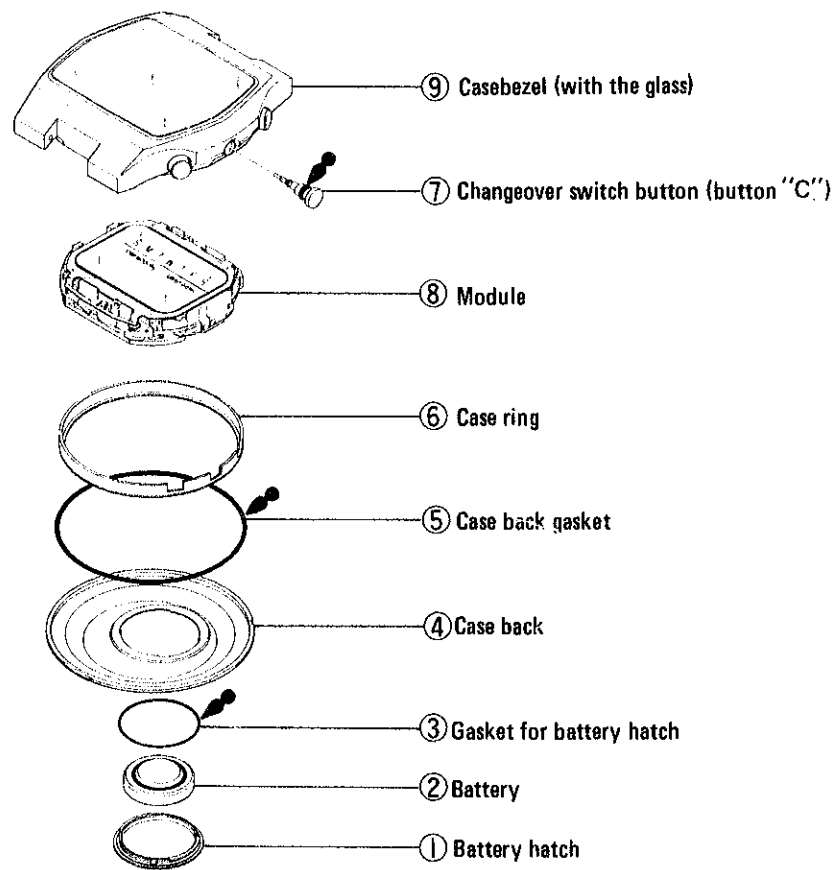

• Disassembling of the glass and the buttons

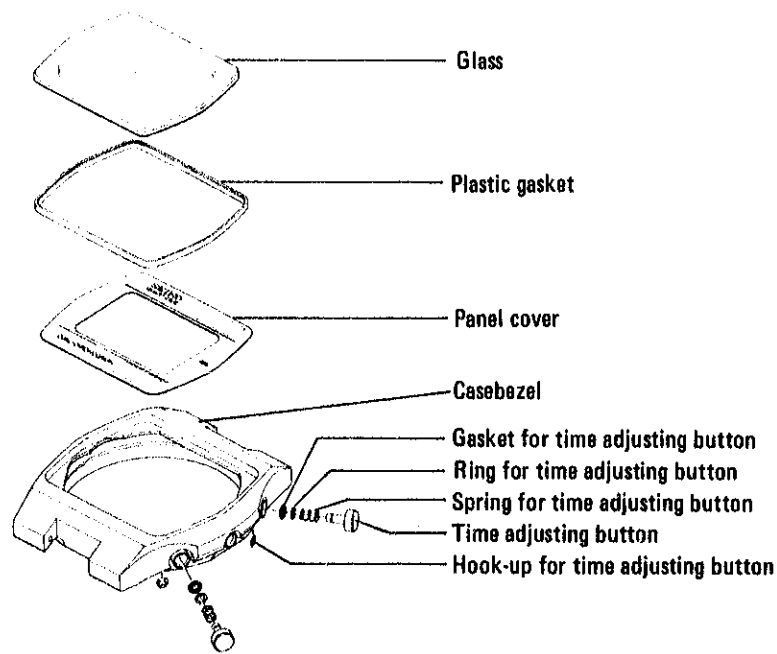

Remarks for disassembling and reassembling

- ⑦ Changeover switch button (button "C")
There are two ways of disassembling the changeover switch button depending on the case type.

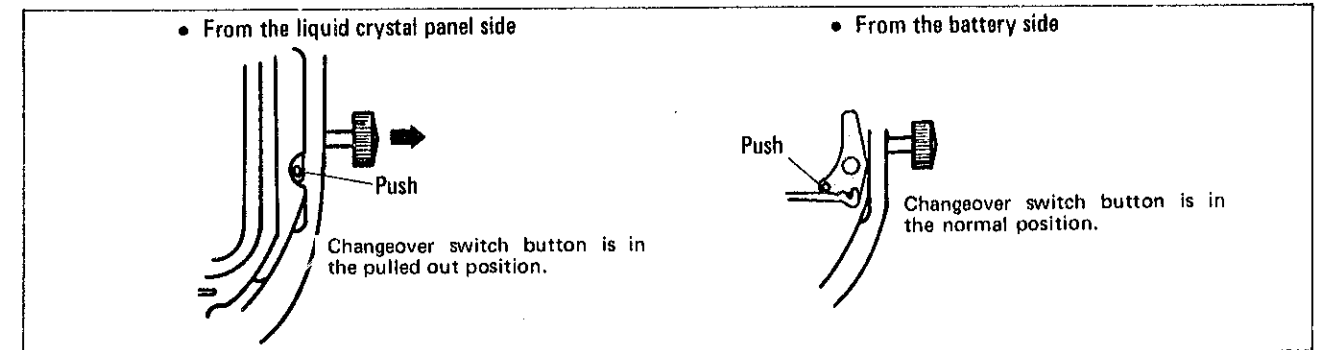

How to replace the glass

• How to disassemble the glass

Use the S-161 Disk or the $\phi 14.5$ mm disk which is contained in the S-160 disk unit and push only the glass.

Be careful not to push the panel cover as the panel cover might bend.

Supporting disk: $\phi 35.0 \sim \phi 36.0$ mm

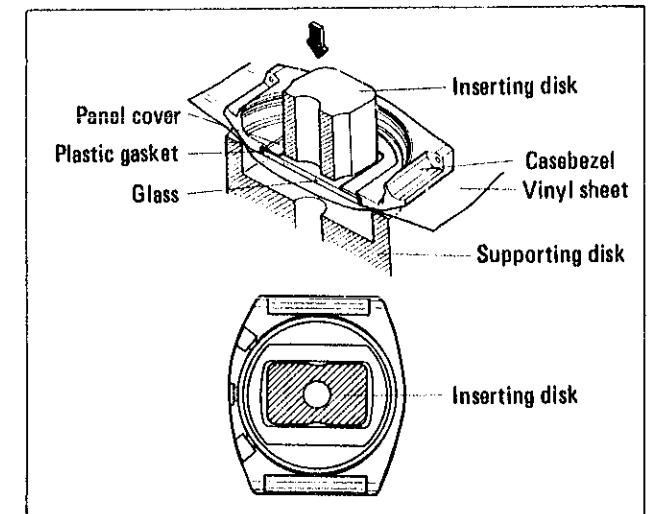
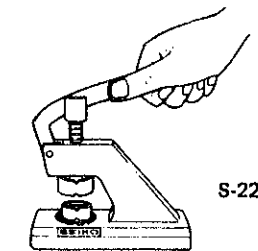

• How to reassemble the glass

- (1) Set the panel cover.
- (2) Set the plastic gasket.
 - Be sure to replace it with a new plastic gasket so as to maintain high water resistance.
 - Do not mistake the upper side for the lower side.
- (3) Set the glass.
 - Do not mistake the upper side for the lower side.
- (4) Push the glass.

Inserting disk: Flat disk (S-173)
Supporting disk: $\phi 26.0 \sim \phi 28.0$ mm

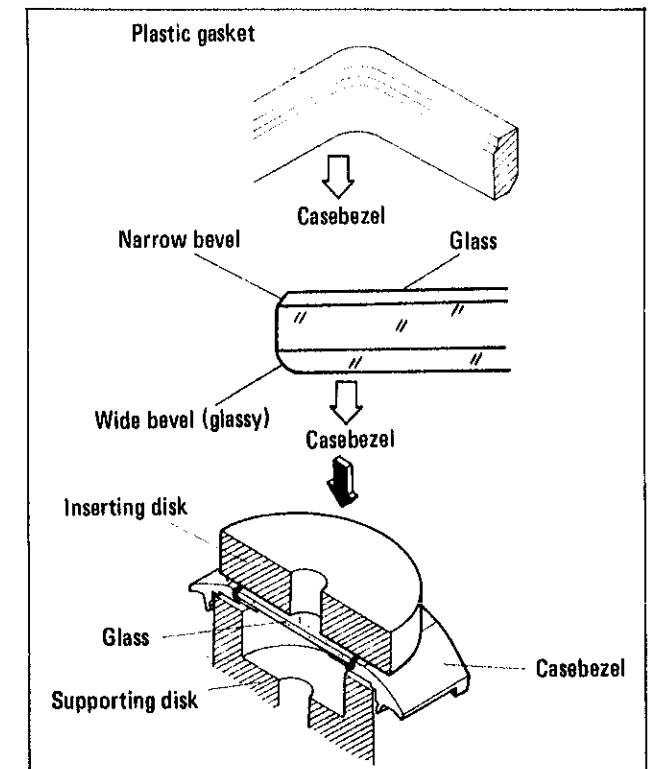

V. DISASSEMBLING, REASSEMBLING, LUBRICATING AND CLEANING

Disassembling procedures Figs.: ①—②⑥
 Reassembling procedures Figs.: ②⑥—①
 Lubricating ● : SEIKO Watch Oil, S-6, normal quantity

1. Liquid crystal panel side

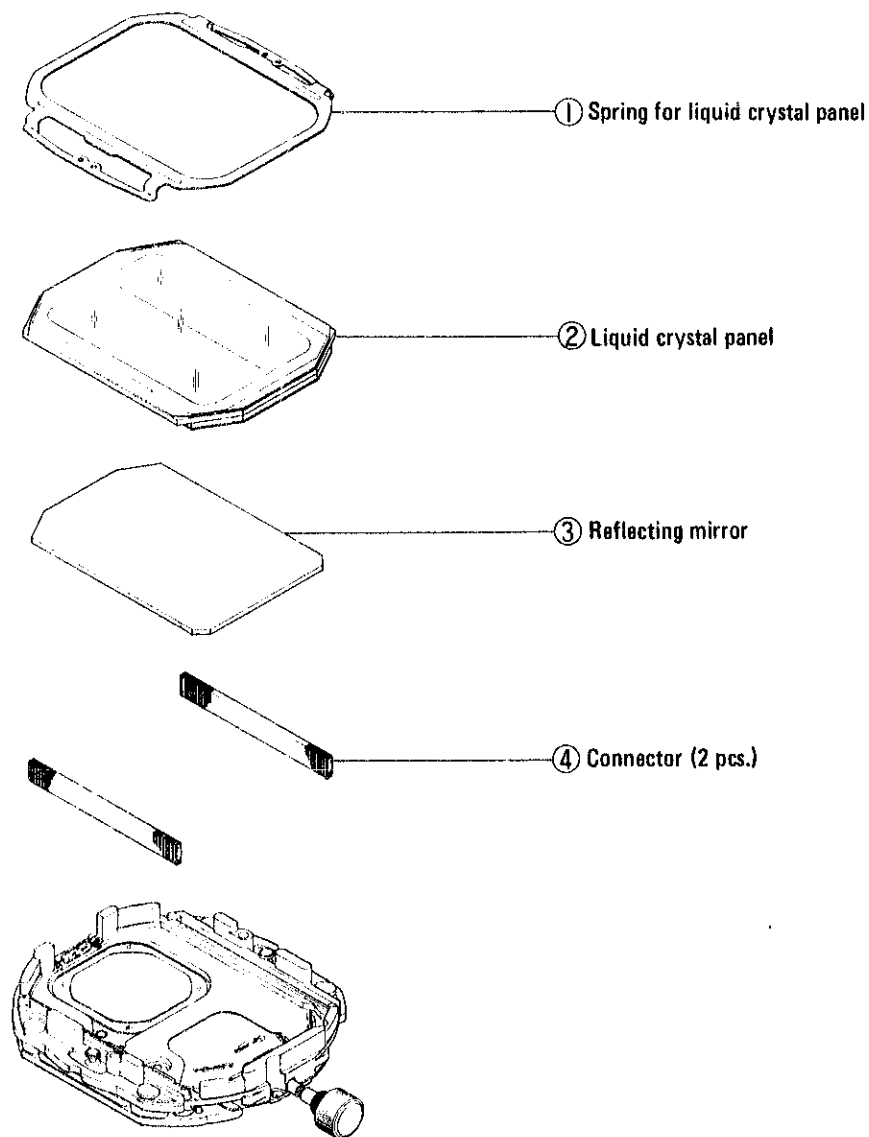

Remarks for disassembling and reassembling

① Spring for liquid crystal panel

Insert the tips of the tweezers into the two holes of the spring for liquid crystal panel and pull it in the arrow-marked direction for disassembling.

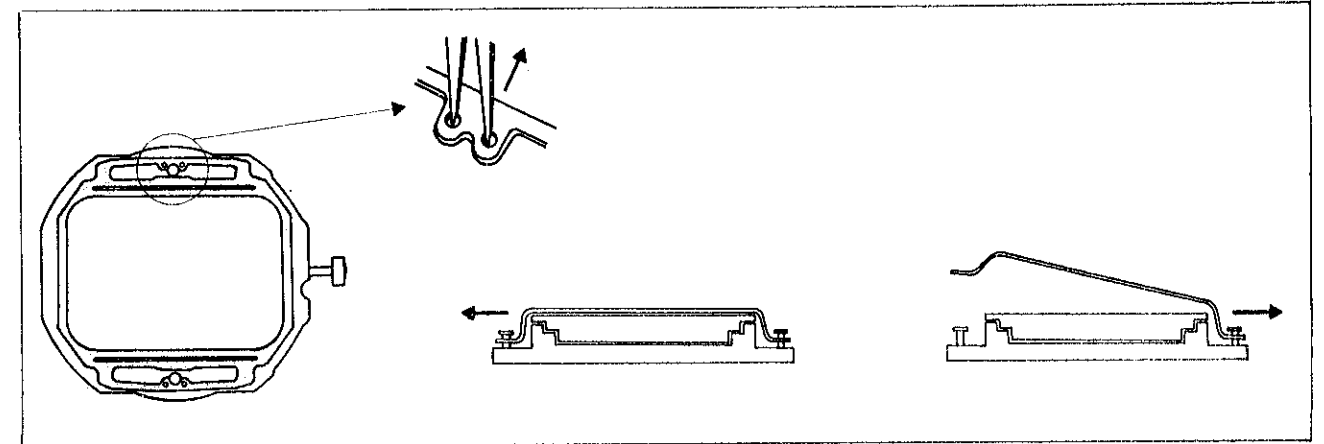

② Liquid crystal panel

Use fingercots to disassemble and reassemble the liquid crystal panel. Be careful not to push the surface of the liquid crystal panel hard.

③ Reflecting mirror

Use fingercots to disassemble and reassemble the reflecting mirror. Be sure not to use tweezers as they may scratch the surface.

④ Connector

Although two connectors are used, there is no difference between the two.

The black portions are conductive. Check to see if there are no scratches or contamination.

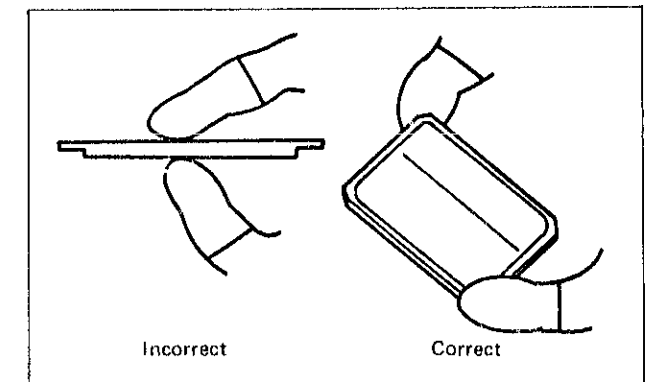

2. Switch mechanism side

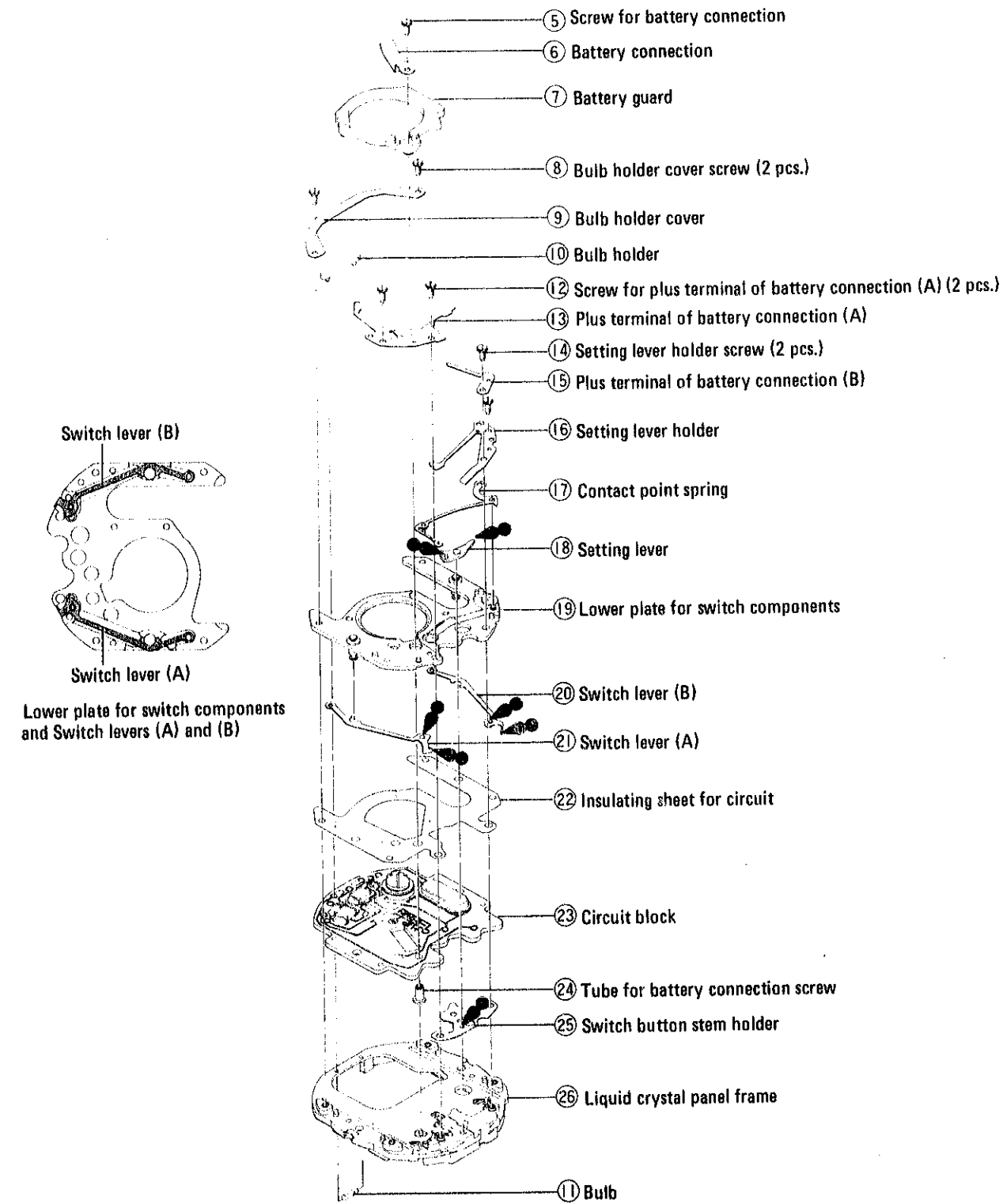

Remarks for disassembling and reassembling

⑪ Bulb

Disassemble the bulb holder cover and the bulb can be replaced without disassembling the switch components.

Be sure to reassemble the bulb so that there is no clearance left between the bulb and the liquid crystal panel frame. Be careful not to touch the bulb lead wire to the patterns.

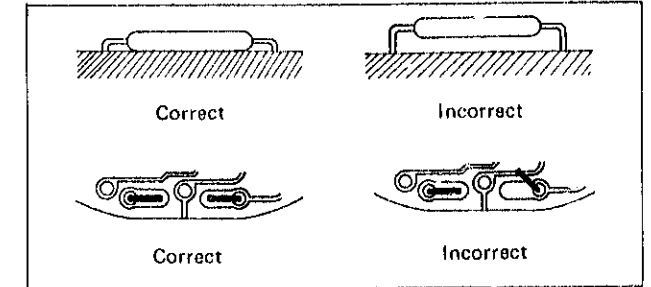

⑰ Contact point spring

How to disassemble

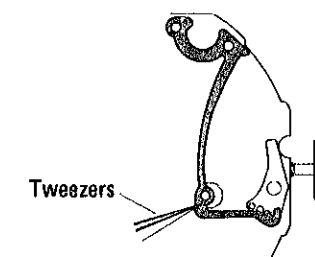

Pull up contact point spring with tweezers for disassembling.

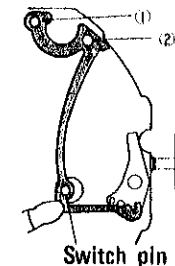

Set the switch pin of the contact point spring in the hole of the lower plate for switch components. Fix the portions ① and ② while holding the switch pin portion with a fingertip. Reassemble the setting lever holder and hook the tip of the contact point spring to the pin of the setting lever.

⑳ Circuit block

Be sure to hold the shadowed portion shown in the illustration on the right by using tweezers or a finger-cot when handling the circuit block.

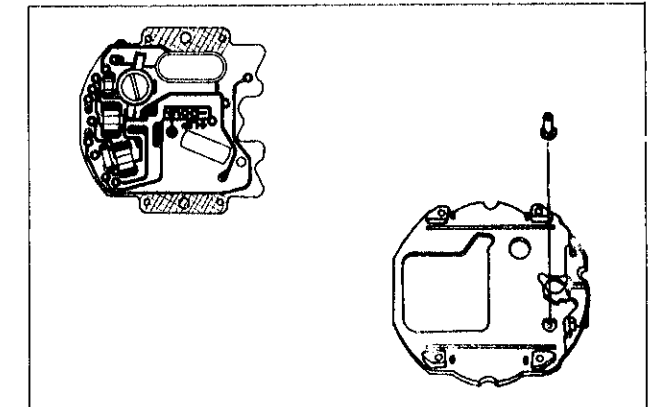

㉑ Tube for battery connection screw

Make sure to reassemble the tube for battery connection screw in the liquid crystal panel frame.

㉒ Liquid crystal panel frame

Be careful not to disassemble the switch springs (4 pcs.) from the liquid crystal panel frame except when replacement of the liquid crystal panel frame is necessary.

Refer to the illustrations below for reassembling the liquid crystal panel.

Switch spring

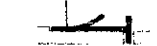

Viewed from the side



Viewed from the above

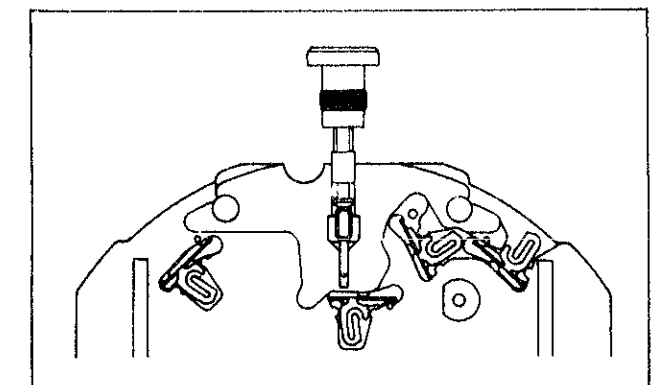

3. Cleaning

1) HOW TO CLEAN

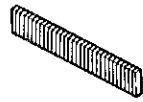
Name of parts	Cleaning	Drying	Solution	Remarks
Connector 	Rinse or wash with a soft brush.	Cool air	Alcohol	<ul style="list-style-type: none"> Do not use benzine or trichloroethylene as they expand the connector. Be sure to reassemble after drying thoroughly.
Plastic parts Battery guard Liquid crystal panel frame Insulating sheet for circuit	Rinse or wash with a soft brush.	Cool air	Alcohol or benzine	
Other parts (except the parts that must not be cleaned)	Clean with cleaner, rinse or wash with a soft brush.	Cool or hot air	Benzine, trichloroethylene or alcohol	

2) PARTS THAT MUST NOT BE CLEANED

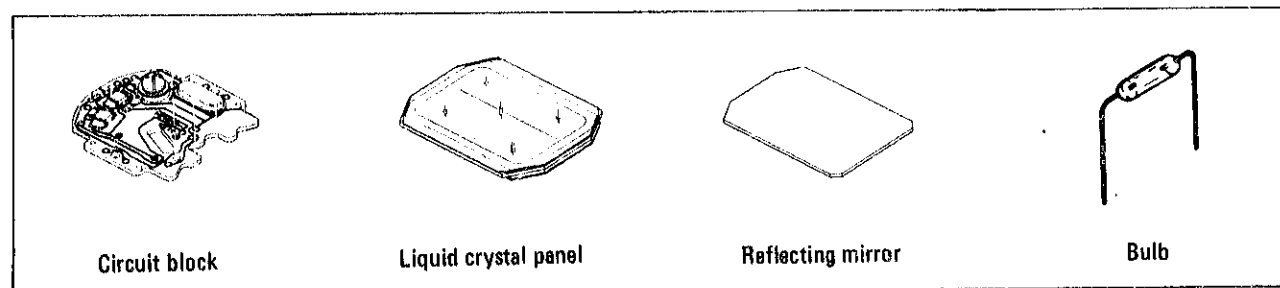

- Only the conductive portions should be wiped with a cloth moistened with benzine or alcohol and dried with cool air.
- Wipe dust and lint off with a brush.

VI. CHECKING AND ADJUSTMENT

1. Guide table for checking and adjustment

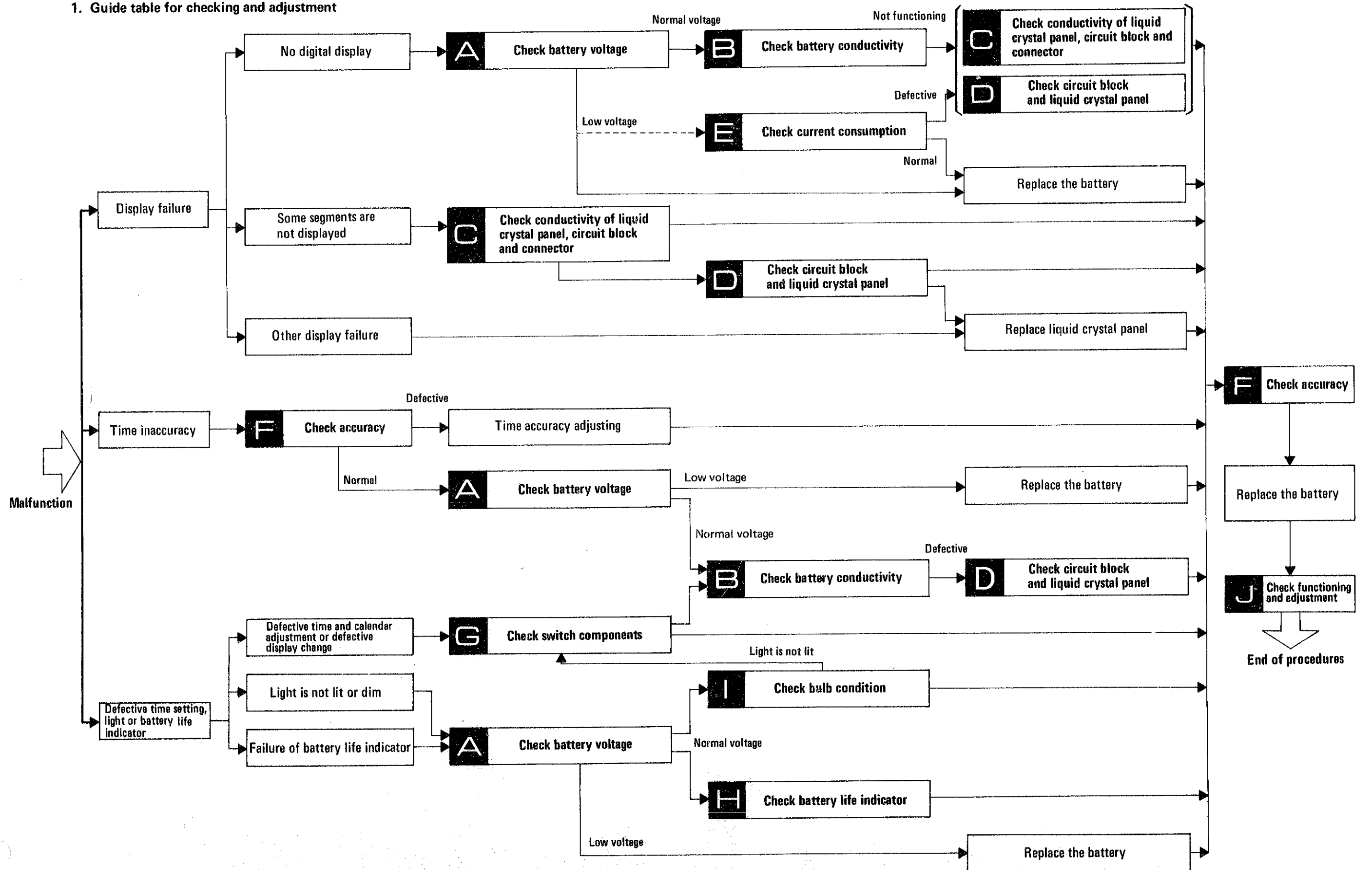



[Note]

If it is difficult to locate the malfunctioning point, proceed to **J Check functioning and adjustment** first.

2. Malfunction and checking points

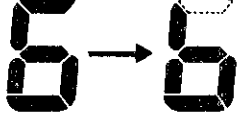
- Check in numerical order.
- Refer to "Procedures for checking and adjustment" on page 19.

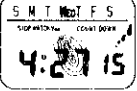
FAULTY SYMPTOMS		CHECKING POINTS							
		A	B	C		D	G	H	I
		Battery voltage	Battery conductivity	Liquid crystal panel	Circuit block	Connector	Circuit block, Liquid crystal panel	Switch components	Battery life indicator
DISPLAY FAILURE	Stop (Though the digits are displayed, digital figures do not change.)	①	②				③		
	No digital display, dim digital display or extremely slow response. 	①	②	③	⑤	④	⑥		
	Some segment of the digital figures are not lighted or dim. 			②	③	①			
	All segments are displayed. 			②	③	①			
	Some portions of the liquid crystal panel will show up as black dots or appear iridescent. 			①					
TIME INACCURACY	Gain or loss tested by the Quartz Tester.	①	②						
	Though the Quartz Tester indicates the normal figures, a watch gains or loses when it is worn on the wrist.	①	②				③		
DEFECTIVE TIME AND CALENDAR SETTING LIGHT OR BATTERY LIFE INDICATOR	Display adjustment is impossible, the display is extinguished while it is being adjusted, or display change-over is impossible.						②	①	
	All digital figures are flashing.	①							②
	Light is not lit or light is lit but dims soon.	①						③	②

3. Relationship between the segment (Liquid Crystal Panel Electrode) and the C-MOS-LSI output terminal

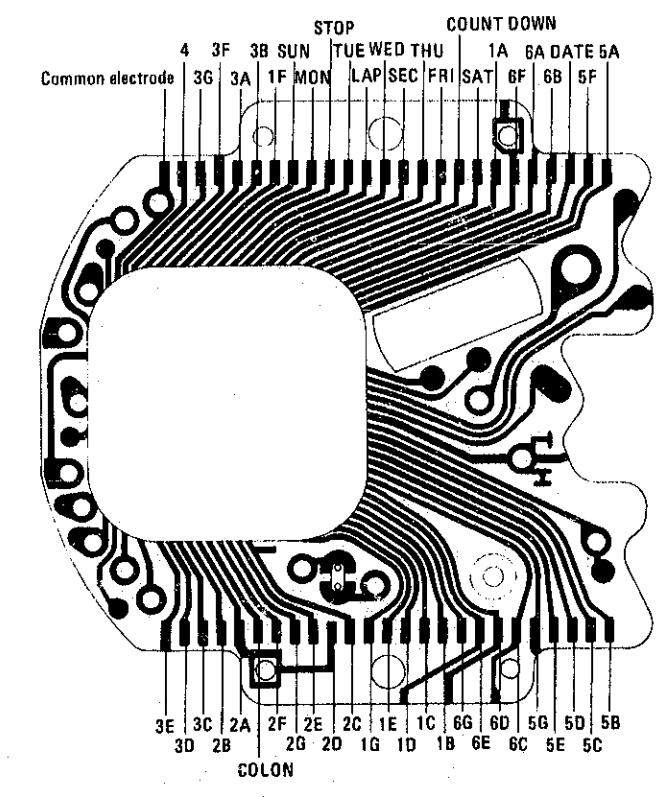
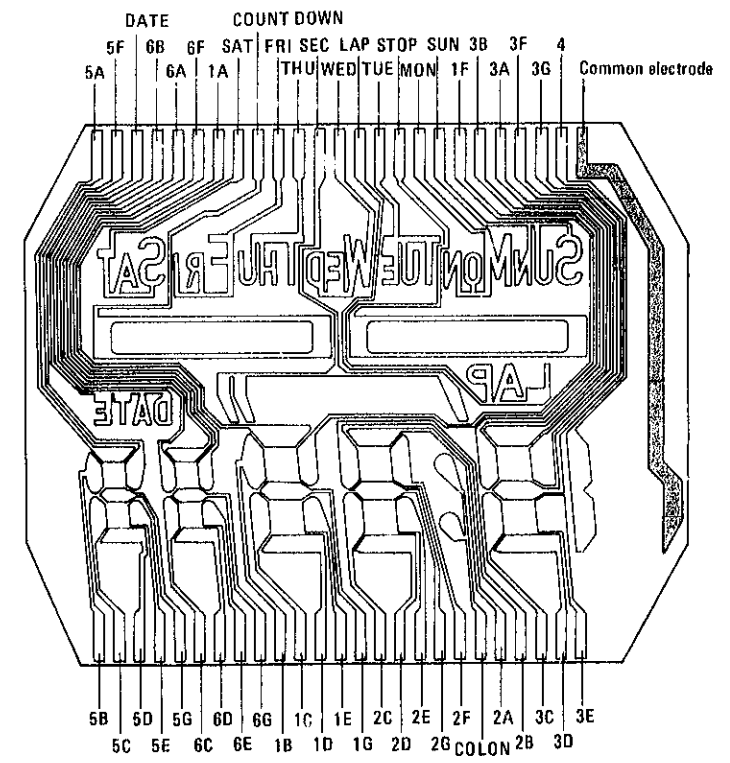

4. Procedures for checking and adjustment

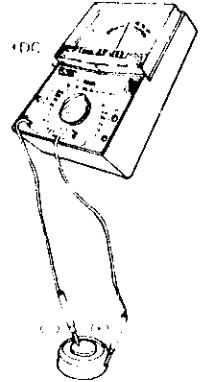
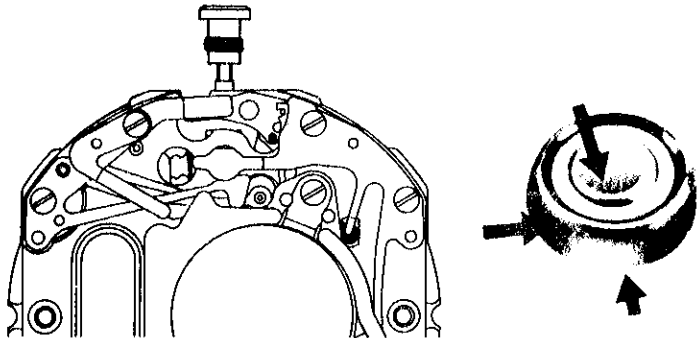
	Procedure	Result and repair
CHECK BATTERY VOLTAGE	<p>Use the following procedures to check the battery voltage.</p> <ul style="list-style-type: none"> Set up the volt-ohm-meter. Range to be used: DC 3V Measuring <ul style="list-style-type: none"> Probe Red (+) Battery surface (+) Probe Black (-) Battery surface (-) 	<p>More than 1.5 V → Normal Less than 1.5V → Defective Replace the battery with a new one.</p>
CHECK BATTERY CONDUCTIVITY	<p>FIRST CHECK Check for any contamination on the battery, battery connection and plus terminal of battery connections (A) and (B).</p> <p>SECOND CHECK Make sure that the screw for battery connection and the screw for plus terminal of battery connection (A) are tightened firmly.</p>  <p>THIRD CHECK Check to see if there is battery electrolyte leakage. When there is battery electrolyte leakage, follow the procedures below.</p> <ol style="list-style-type: none"> Remove the module from the case and clean the parts contaminated with battery electrolyte. <ul style="list-style-type: none"> Clean the circuit block. <ol style="list-style-type: none"> Wipe off battery electrolyte with a cloth moistened with distilled water. (If distilled water is not available, use tap water.) Then wipe it off with a cloth moistened with alcohol. <p>NOTE:</p> <ul style="list-style-type: none"> Do not use a cloth which gives off lint such as gauze, flannel, etc. Do not expose the trimmer condenser to water or alcohol. <ol style="list-style-type: none"> Dry with cool air by using a dryer. Clean the other parts. <ol style="list-style-type: none"> Wipe off battery electrolyte on the other parts with a soft brush moistened with distilled water. (If distilled water is not available, use normal tap water.) Then rinse them with alcohol. Dry with cool air by using a dryer. Reassemble the module. Replace the battery with a new one. Check to see if the time and calendar setting functions and the current consumption are normal. 	<p>Uncontaminated → Normal Contaminated → Defective Wipe off any foreign matter.</p> <p>No loosened screws → Normal Loosened screws → Defective Retighten screws.</p> <p>No battery electrolyte leakage → Normal Battery electrolyte leakage → Defective Wipe off battery electrolyte by following the repairing procedures on the left.</p>

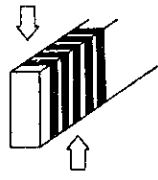
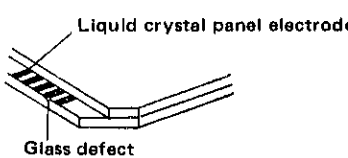
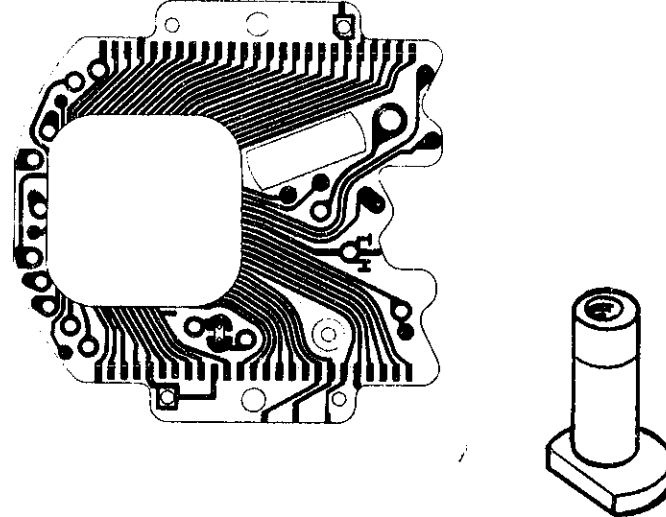
	Procedure	Result and repair
CHECK CONDUCTIVITY OF LIQUID CRYSTAL PANEL, CIRCUIT BLOCK AND CONNECTOR	<ol style="list-style-type: none"> Check for any contamination, scratch, crack and break of the connector. <ul style="list-style-type: none"> Be sure to check the connecting portion with the liquid crystal panel and the circuit block carefully.  Check for any contamination and glass defect of the liquid crystal panel electrode (the connecting portion with the connector).  Check for any contamination on the circuit block electrode and the tube for battery connection screw.  	<p>No contamination, scratch, crack or break → Normal Contaminated → Defective Wipe off any foreign matter.</p> <p>No contamination or glass defect → Normal Contaminated → Defective Wipe off any foreign matter. Glass defect → Replace the liquid crystal panel with a new one.</p> <p>Uncontaminated → Normal Contaminated → Defective Wipe off any foreign matter.</p>

D

- Procedure**
1. Check to see if the electric signal flows into the liquid crystal panel from the circuit block correctly.
 - (1) Set the battery in the module and hold by the battery holding spring.
 - (2) Disassemble the spring for liquid crystal panel and the liquid crystal panel by following the disassembling procedures.
 - (3) Set up the volt-ohm-meter.
Range to be used: DC 3V
 - (4) Measuring
Probe Red (+) . . . Pin on the lower plate for switch components.
Probe Black (-) . . . Black portions of the connector.
(Apply to several portions.)

[NOTE]

Be sure to touch the connector lightly with the probe.

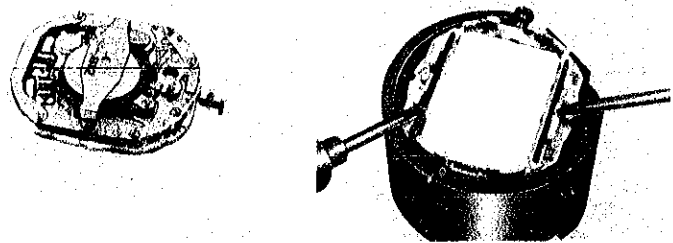

2. Check for any broken panel pattern, short circuit, etc. of the liquid crystal panel.
 - (1) Set up the volt-ohm-meter.
Range to be used: OHMS R X 1
(Any range will do if more than 3V is applied to the terminal of the volt-ohm-meter.)
 - (2) Disassemble the liquid crystal panel from the module and turn the liquid crystal panel upside down.
 - (3) Measuring
Apply one of the two probes to the common electrode of the liquid crystal panel (Either red or black probe will do.) and the other probe to the segment electrode.

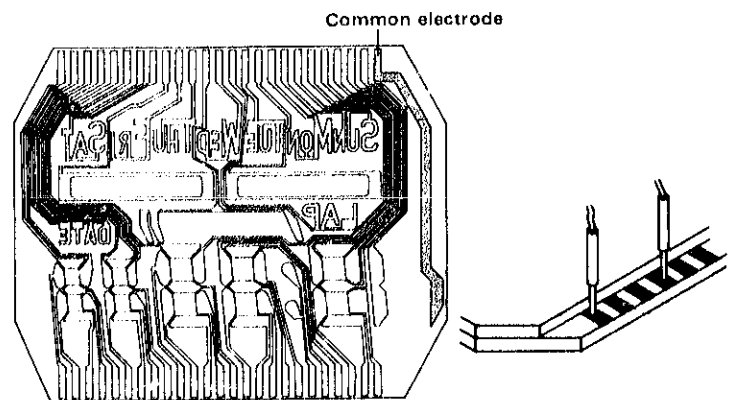

Result and repair

More than 0.8 V → Normal
 Less than 0.8 V → Defective
 Replace the circuit block with a new one.
 (The above voltage is obtained when measured by the volt-ohm-meter S-831 (or AF-105) mentioned on the Technical Guide or a volt-ohm-meter whose internal resistance is higher than that of the S-831 (or AF-105).)

Lights up → Normal
 Does not light up → Defective
 Replace the liquid crystal panel with a new one.

M

CHECK CURRENT CONSUMPTION

- Procedure**
- Check to see if the current consumption is normal.
1. Set up the volt-ohm-meter.
Range to be used: DC 12 μ A (by using S-831)
DC 0.03 mA (by using AF-105)
 2. Measuring
Probe Red (+) . . . Battery connection
Probe Black (-) . . . Battery surface (-)

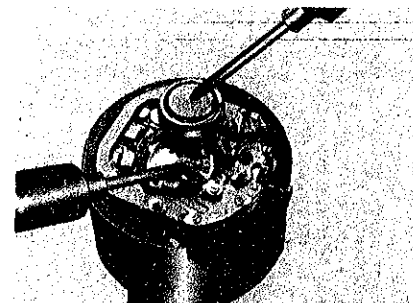

Place on the metal case of the crystal oscillator with the battery surface (-) up.

Less than 3.5 μ A → Normal
 More than 3.5 μ A → Defective
 Proceed to (B), (C) and (D).

T

CHECK ACCURACY

- Procedure**
- Check gain and loss of time.
 Set up the Quartz Tester.
 When the Quartz Tester QT-77 is used
- (1) Set the microphone switch (Electro-magnetic and Electric-field detection Changeover-Power switch) to LC ON position.
 - (2) Push the watch selection button (LC button).

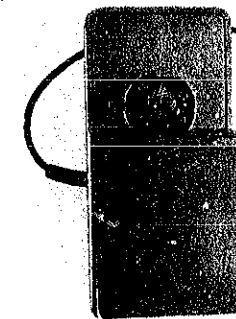

If the watch tends to gain or lose, proceed to Time accuracy adjusting.



• HOW TO ADJUST TIME ACCURACY

The watch will gain or lose according to the direction in which the trimmer condenser is turned. NOTE for handling the trimmer condenser.

- (1) Avoid excessive depressing of the trimmer condenser when turning.
- (2) Avoid excessive turning of the trimmer condenser as it is a precision part.

G

1. Check for any contamination, break or bent of the switch spring (4 pcs.) and the switch pins (A), (B), (C) and (D).

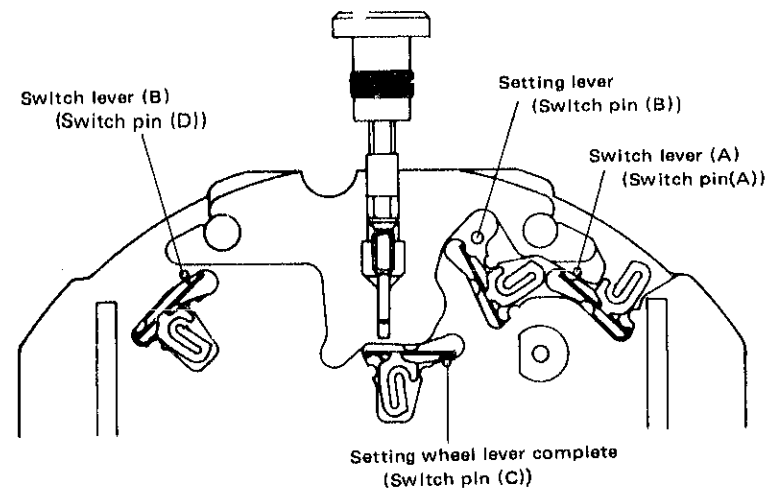

No contamination, break → Normal
 Contaminated → Defective
 Wipe off any foreign matter.
 Break or bent → Defective
 Replace the broken part (with the switch pin) or the switch spring with a new one.

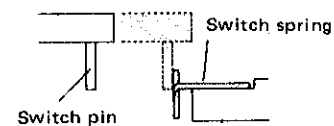

• The contact of the switch spring with the switch pin will enable the following functions to be operated.

Position of changeover switch button (button "C")	Switch pin			
	A	B	C	D
Normal position	Changeover to and from the date display and the second display.	---	---	Illuminating light is activated.
Pulled out position	Select the digits.	Digits are ready to be adjusted. "STOP-WATCH 1/100" mark is displayed.	---	Set the digits.
Pushed in position	---	---	Display changeover Time → Stop-watch ↓ Count-down	---

I

CHECK BATTERY LIFE INDICATOR

Procedure

Result and repair

FIRST CHECK

- Set up the Micro Test.
Set the voltage at 1.1 V.
- Apply the terminals of the Micro Test and check the digital display on the liquid crystal panel.
Clip Red (+) Changeover switch button
Probe Black (-) Battery connection

Display flashes → Normal
 Display does not flash → Defective
 Replace circuit block.

SECOND CHECK

- Set up the Micro Test.
Set the voltage at 1.5 V.
- Apply the terminals of the Micro Test and check the digital display on the liquid crystal panel.
Clip Red (+) Switch button
Probe Black (-) Battery connection

Display does not flash → Normal
 Display flashes → Defective
 Replace circuit block.

I

CHECK BULB CONDITION

Check to see if there is a broken filament in the bulb.

- Set up the volt-ohm-meter.
Range to be used: OHMS R X 1
- Measuring
Apply red and black probes of the volt-ohm-meter to the two terminals of the bulb. (Either red or black probe will do.)

Lights up → Normal
 Does not light up → Defective
 Replace the bulb with a new one.

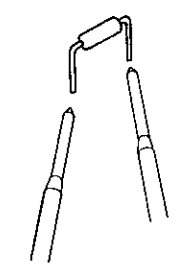

Check to see if display changeover and adjustment can be made correctly by button operation.

FIRST CHECK

Check to see if the time and calendar display, stopwatch display and countdown display are changed over into the desired display by depressing button "C" (Changeover switch button).

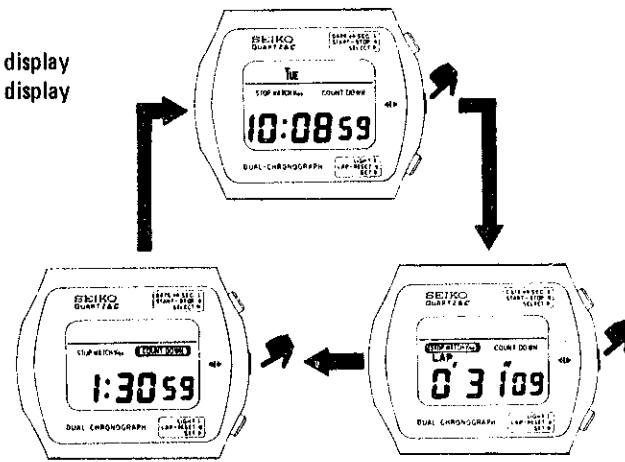

SECOND CHECK

Check to see if each digit is selected and set by pulling out button "C" in the time and calendar display. (Refer to "How to set the time and calendar" for the selecting and setting procedures.)

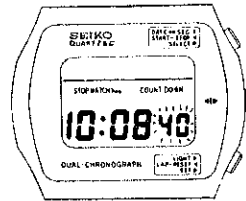

THIRD CHECK

Check to see if the stopwatch is operated correctly. (Refer to "How to use the stopwatch".)

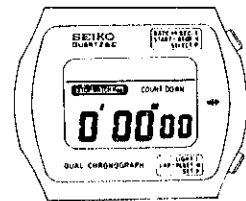

FOURTH CHECK

Check to see if the countdown function is operated correctly. (Refer to "How to use the countdown function".)

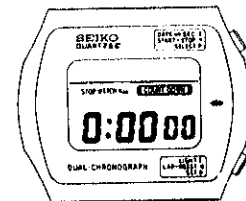

FIFTH CHECK

Check to see if the illuminating light is lit by depressing button "B".

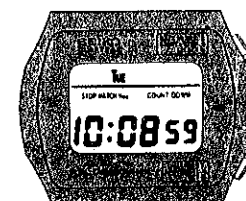

All procedures of Disassembling and Reassembling, and Checking and Adjustment are completed.