

**SEIKO**

**DIGITAL QUARTZ**

**Cal. L221A**

**PARTS LIST**

# Cal. L221A

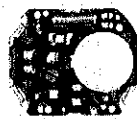

4001 117



4216 047



4270 027



4313 022



4398 052



4457 005



☆4510 241



4521 020



☆SEIKO SB-DL

# Cal. L221A

## Characteristics

Casing diameter:  $\phi$  17.50 mm  
 Maximum height: 3.90 mm without battery  
 Frequency of quartz crystal oscillator: 32,768 Hz (Hz = Hertz . . . . Cycle per second)  
 Time functions: 12-hour Digital Display System showing hour, minute and second.  
 Calendar functions: Digital Display System showing day and date by depressing the side button.  
 Display medium: Single Crystal Display (Nematic Liquid Crystal, FE-Mode)  
 Time micro adjustor: Trimmer condenser system.  
 Battery life indicator: All the digits in the display begin flashing.

PART NO.	PART NAME	PART NO.	PART NAME
4001 117	Circuit block (with liquid crystal panel frame)		
4216 047	Insulator for battery		
4270 027	Battery connection		
4313 022	Connector		
4398 052	Battery guard		
4457 005	Circuit block cover with switch spring		
☆4510 241	Liquid crystal panel (Silver)		
☆4510 242	Liquid crystal panel (Gold)		
4521 020	Reflecting mirror		
☆SEIKO SB-DL	Silver peroxide battery		

### Remarks:

#### Liquid crystal panel

☆4510 241 ) ..... Be sure that combination between the color of panel cover and liquid crystal panel should  
 ☆4510 242 ) ..... be matched according to the "SEIKO Quartz Casing Parts List".

#### Battery

☆ SEIKO SB-DL ..... The applied battery for this calibre might be added the substitutive in the future. in that case, please refer to separate "BATTERIES FOR SEIKO QUARTZ WATCHES".

☆ ⇨ Please see remarks.

Part numbers in light letters are not shown in photos.

# TECHNICAL GUIDE

## SEIKO DIGITAL QUARTZ

CAL. L221A

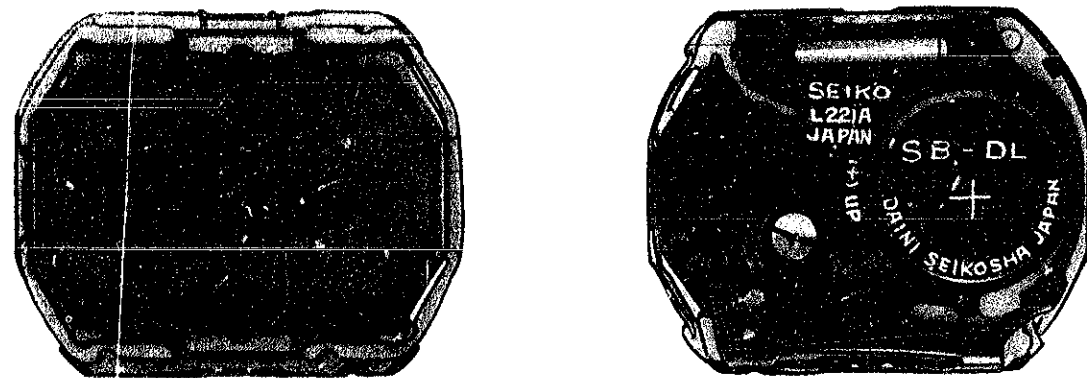

### CONTENTS

I. SPECIFICATIONS AND FEATURES .....	1
1. Specifications .....	1
2. Features .....	1
II. AFTER-SALE SERVICING INSTRUMENTS AND MATERIALS .....	2
III. CASE .....	2
1. How to disassemble the module .....	2
2. How to replace the glass .....	2
IV. DISASSEMBLING AND REASSEMBLING .....	3
1. Liquid crystal panel side .....	3
2. Battery side .....	5
V. CHECKING AND ADJUSTMENT .....	8
1. Guide table for checking and adjustment .....	8
2. Procedures for checking and adjustment .....	10
A : Check battery voltage .....	10
B : Check battery conductivity .....	10
C : Check conductivity of liquid crystal panel, circuit block and connector .....	11
D : Check switch components .....	11
E : Check circuit block and liquid crystal panel .....	12
F : Check current consumption .....	12
G : Check accuracy .....	13
H : Check battery life indicator .....	13
I : Check functioning and adjustment .....	14

Calibre L221A

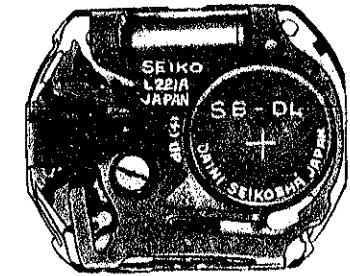
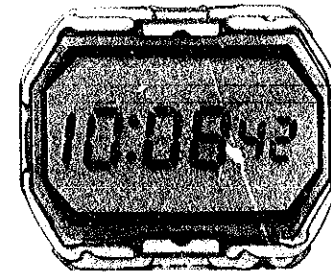

Module

## I. SPECIFICATIONS AND FEATURES

### 1. Specifications

Item	Calibre No. L221A
Display medium	Nematic Liquid Crystal, FEM (Field Effect Mode)
Display system	<ul style="list-style-type: none"> <li>• Time display (Constant display) Hour, minute &amp; second: 12-hour digital display system</li> <li>• Calendar display (The calendar digits are displayed for 2 seconds by depressing button (A) when the time digits are displayed.)</li> <li>• Day and date: Automatic calendar system (Automatically adjusts for even and odd months except February of leap years.)</li> <li>• Month, A.M. (□) &amp; P.M. (□) are displayed when the time and calendar digits are adjusted.</li> </ul>
Additional mechanism	Battery life indicator (All the digits in the display start flashing when the battery life nears its end.)
Crystal oscillator	32,768 Hz (Hz = Hertz . . . Cycle per second)
Loss/gain	Loss/gain at normal temperature range Monthly rate : less than 15 seconds (Annual rate : less than 3 minutes)
Casing diameter	φ17.5mm (14.0mm between 6 o'clock and 12 o'clock sides; 17.0mm between 3 o'clock and 9 o'clock sides)
Height	3.9mm without battery
Operational temperature range	-10°C ~ +60°C (14°F ~ 140°F)
Regulation system	Trimmer condenser
Battery power	SEIKO SB-DL Battery life is approximately 2 years. Voltage: 1.55V
IC (Integrated Circuit)	C-MOS-LSI . . . 1 unit

### 2. Features

SEIKO Ladies' Digital Quartz Cal. L221A has the same accuracy and reliability for which the existing SEIKO Digital Quartz watches are known. It has been made even smaller and thinner for ladies' timepieces.

- (1) In addition to the "hour", "minute" and "second" digits, the "day" letters (alpha) and "date" digits also are displayed by button operation.
- (2) The "day" letters (alpha) are displayed in English.
- (3) It has an automatic calendar system, and therefore even and odd months are automatically adjusted except February of leap years.
- (4) With the simplified block system of the module, it is easier to provide after-sale servicing. (No screws are used in the module.)

## II. AFTER-SALE SERVICING INSTRUMENTS AND MATERIALS

For after-sale servicing of SEIKO Ladies' Digital Quartz Cal. L221A, the following instruments and materials are necessary.

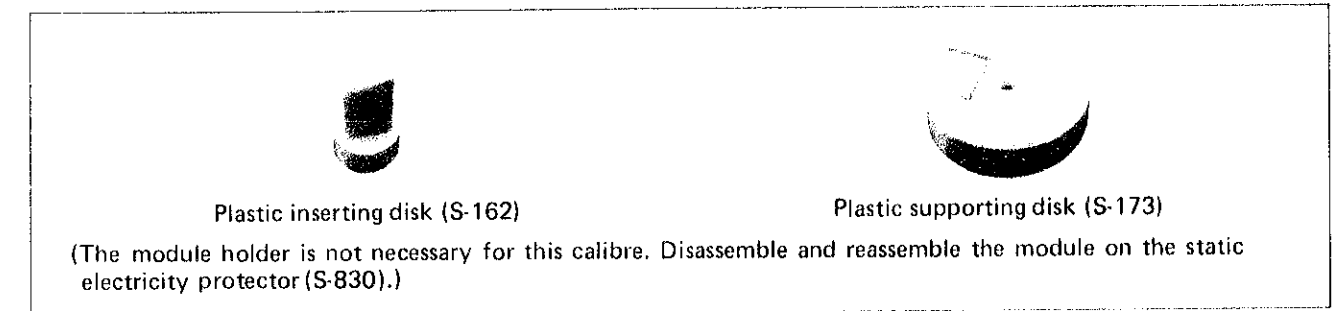

## III. CASE

### 1. How to disassemble the module

• Lubricating Silicone grease 500,000 c.s. Normal quantity

Example: Case No. L 221-5000

- How to reassemble the case back gasket

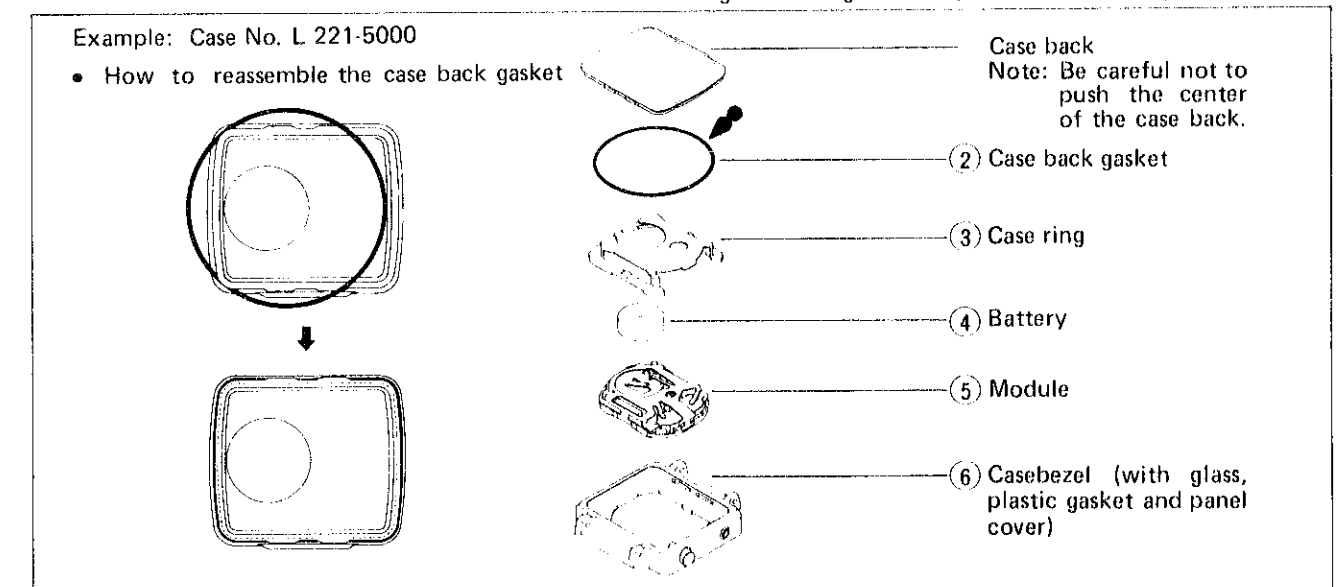

### 2. How to replace the glass

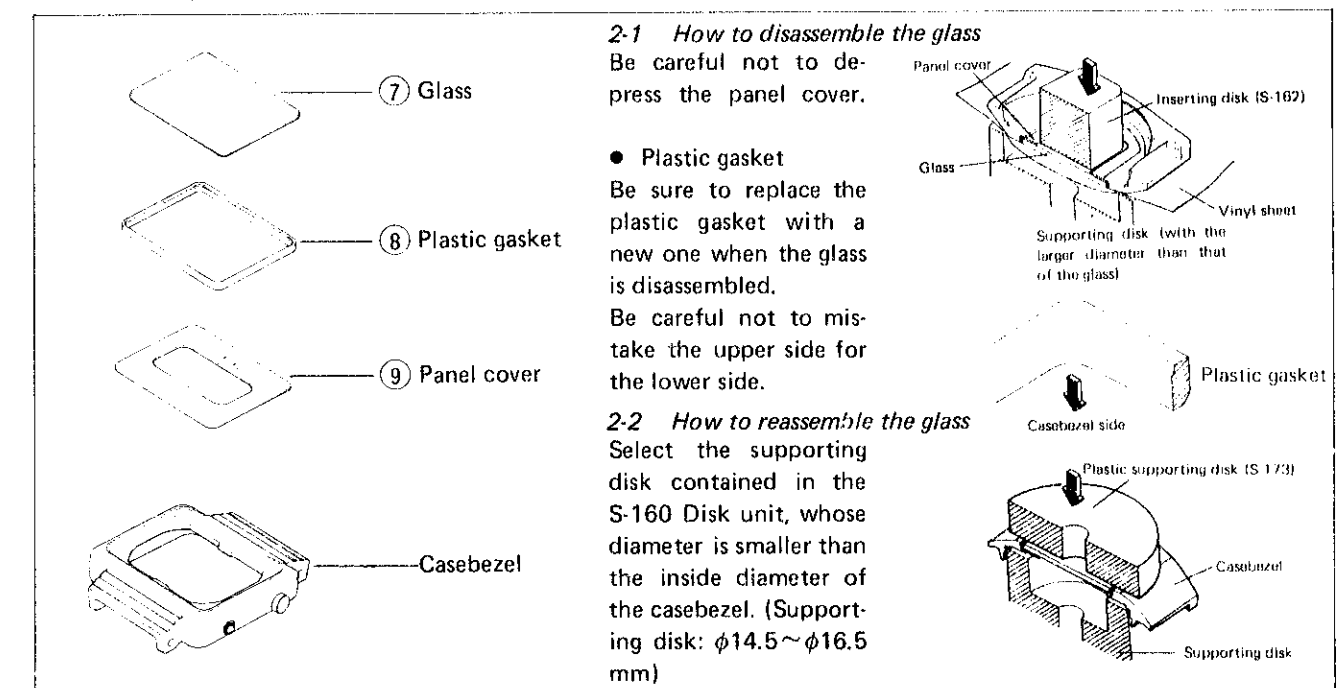

#### IV. DISASSEMBLING AND REASSEMBLING

Disassembling procedures Figs.: ① ~ ⑧

Reassembling procedures Figs.: ⑧ ~ ①

##### 1. Liquid crystal panel side

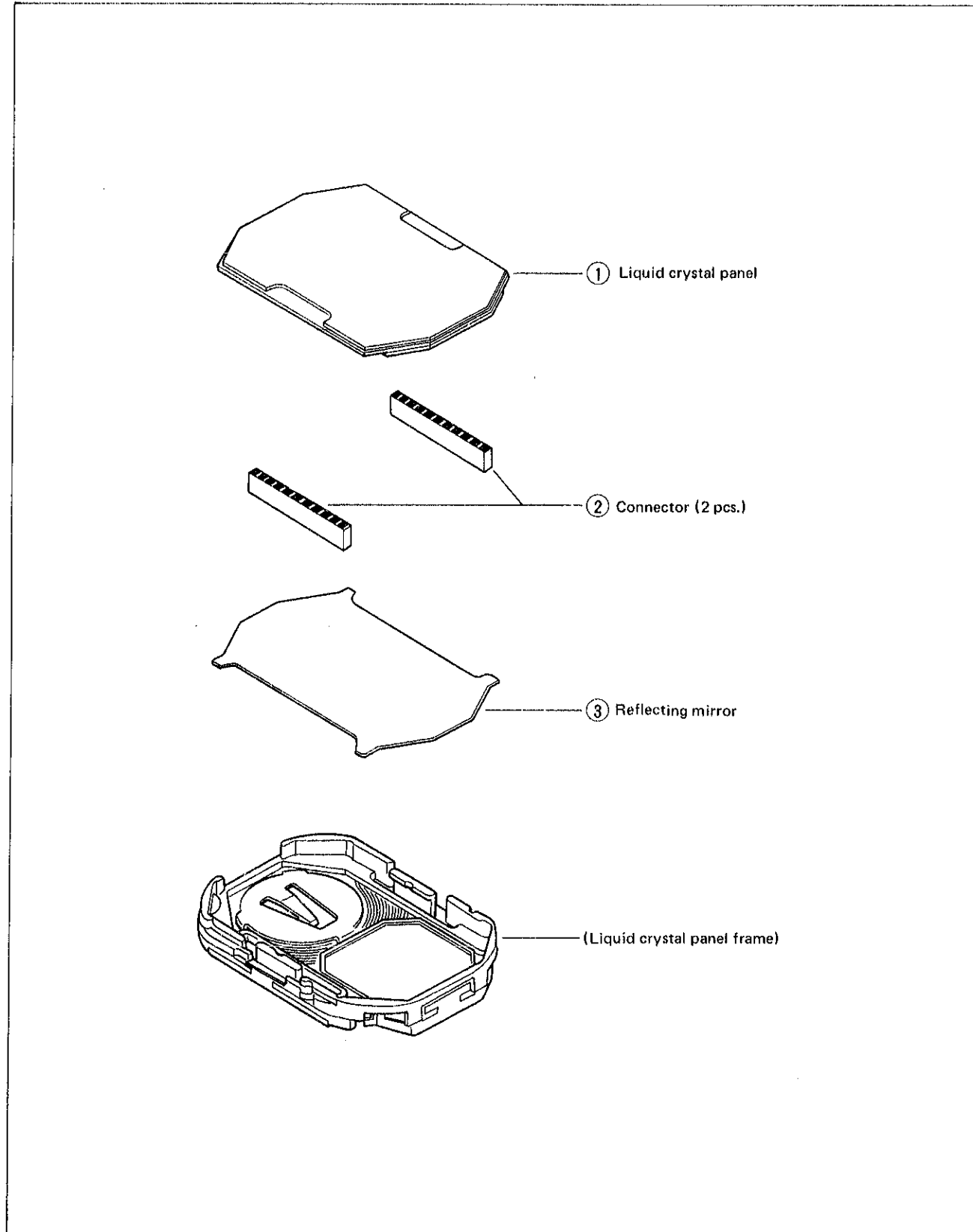

#### Remarks for disassembling and reassembling

##### ① Liquid crystal panel

###### • How to disassemble the liquid crystal panel

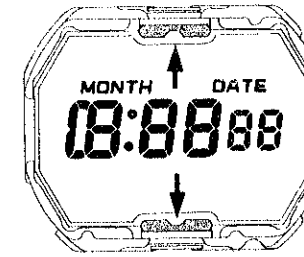

• Push the liquid crystal panel frame (arrow-marked portions ←) outward (in the arrow-marked direction ⇄) with tweezers and disassemble the liquid crystal panel. Be careful not to scratch the liquid crystal panel.

###### • How to reassemble the liquid crystal panel

1) Reassemble the liquid crystal panel in such a manner that its part number portion comes to the upper side when the cut (arrow-marked portion) of the liquid crystal panel frame is on the left side as shown in the illustration.

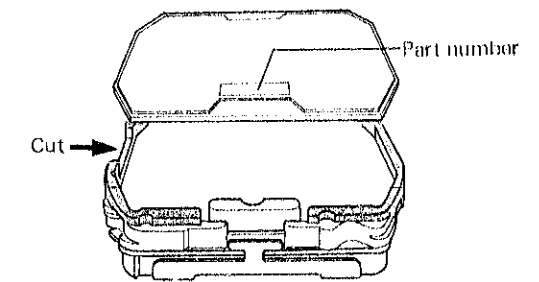

2) First set the liquid crystal panel between the liquid crystal panel frame and the connector and then reassemble it by pushing the liquid crystal panel frame inward.

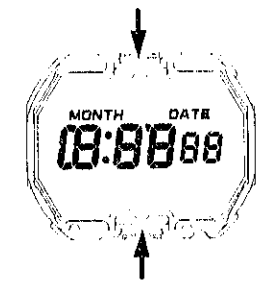
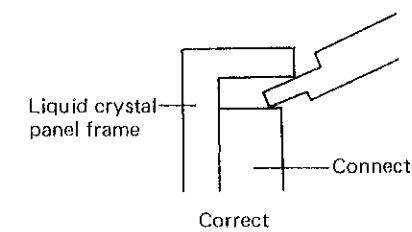

3) Finally check the connecting portions of the liquid crystal panel and the connectors.

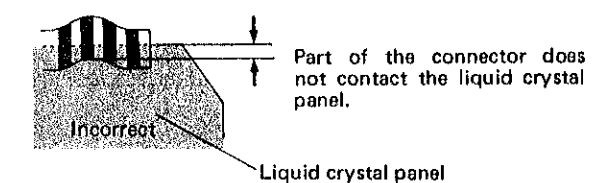
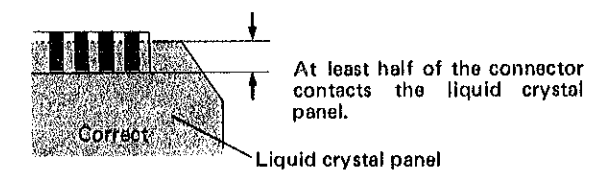
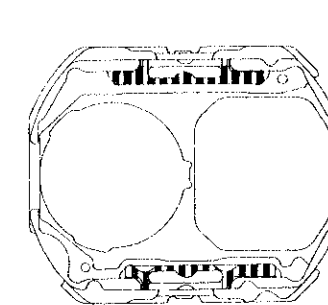

##### ② Connector

There is no difference between the two connectors. The black portions are conductive. Check to see if there is any scratch or contamination.

2. Battery side

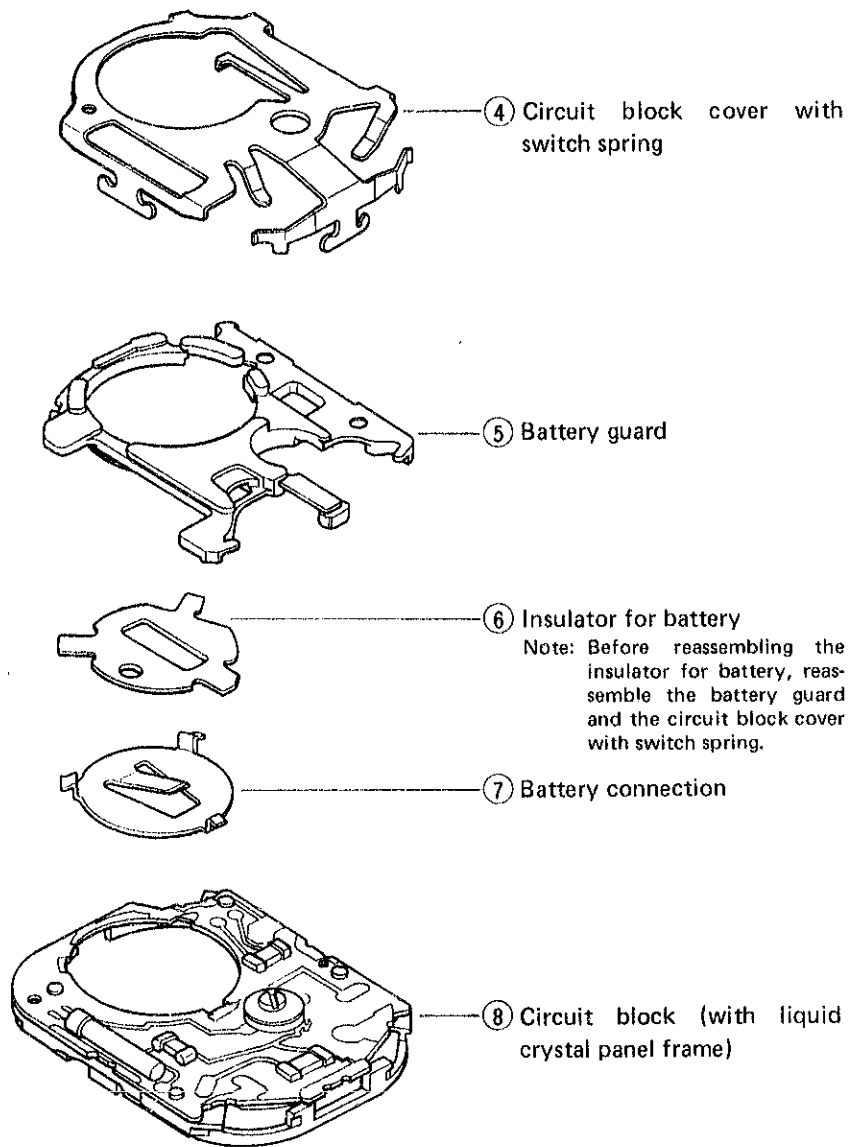

Remarks for disassembling and reassembling

④ Circuit block cover with switch spring

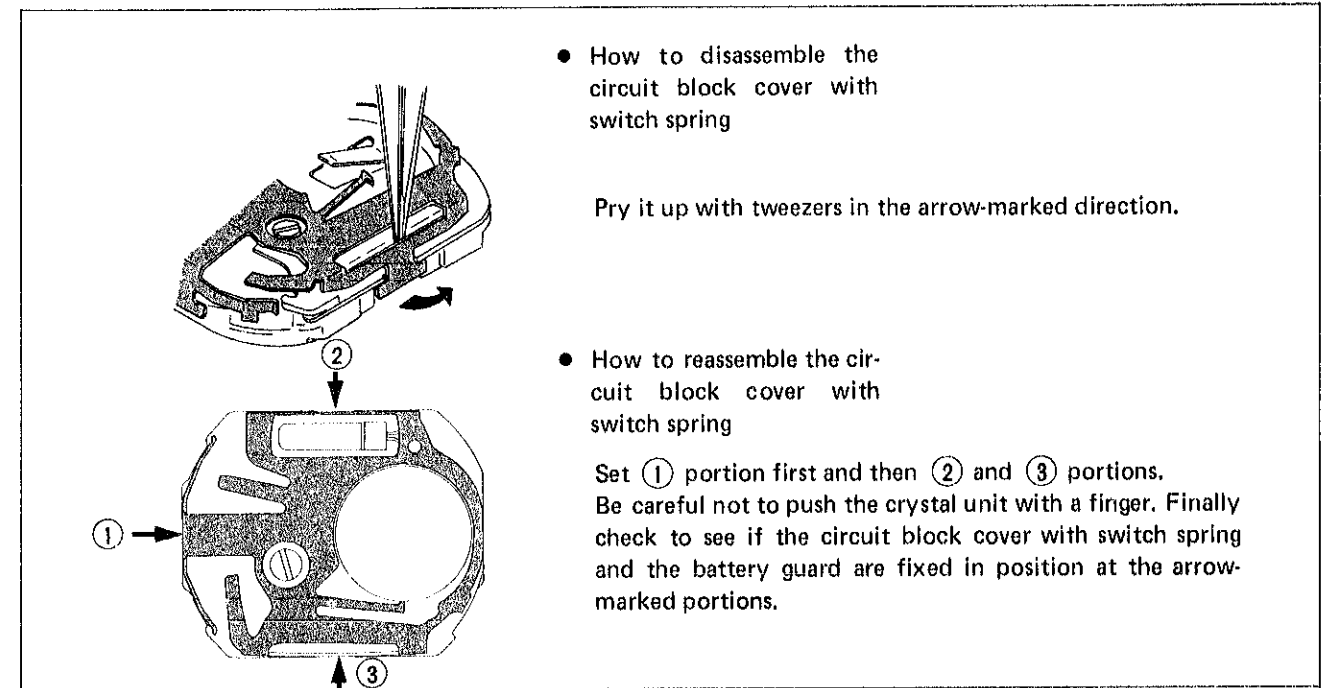

⑤ How to reassemble the battery guard

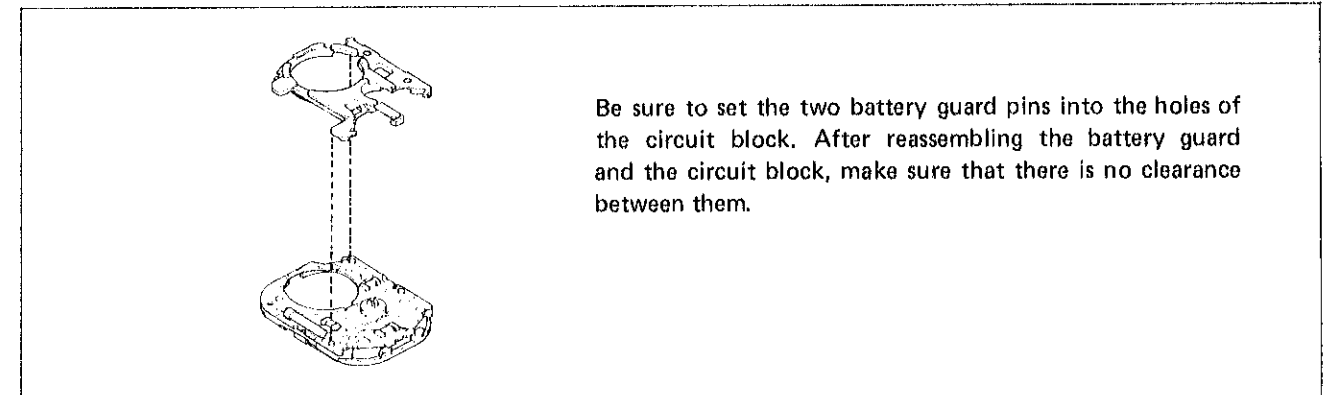

⑥ How to reassemble the insulator for battery

After reassembling the battery guard and the circuit block cover with switch spring, reassemble the insulator for battery in accordance with the following procedures.

- 1) First insert the B portion of the three protrusions of the insulator for battery into the space between the battery connection and the battery guard. Be sure to set it in position.
- 2) Next push the remaining two portions A and C with tweezers to set them in position. Be careful not to scratch the battery guard.

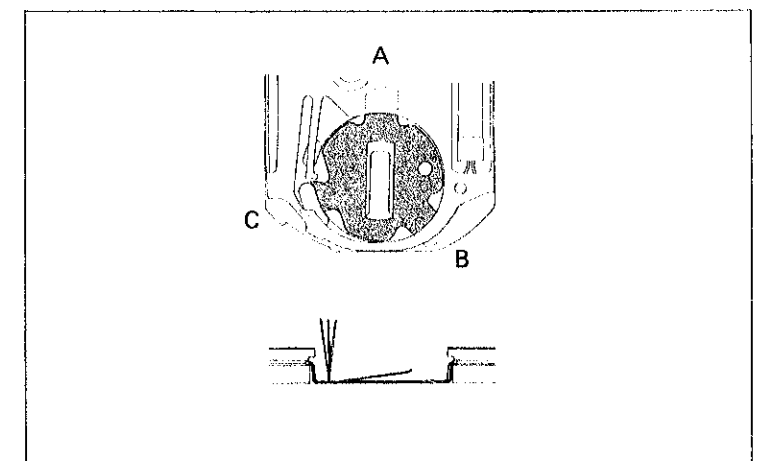



## V. CHECKING AND ADJUSTMENT

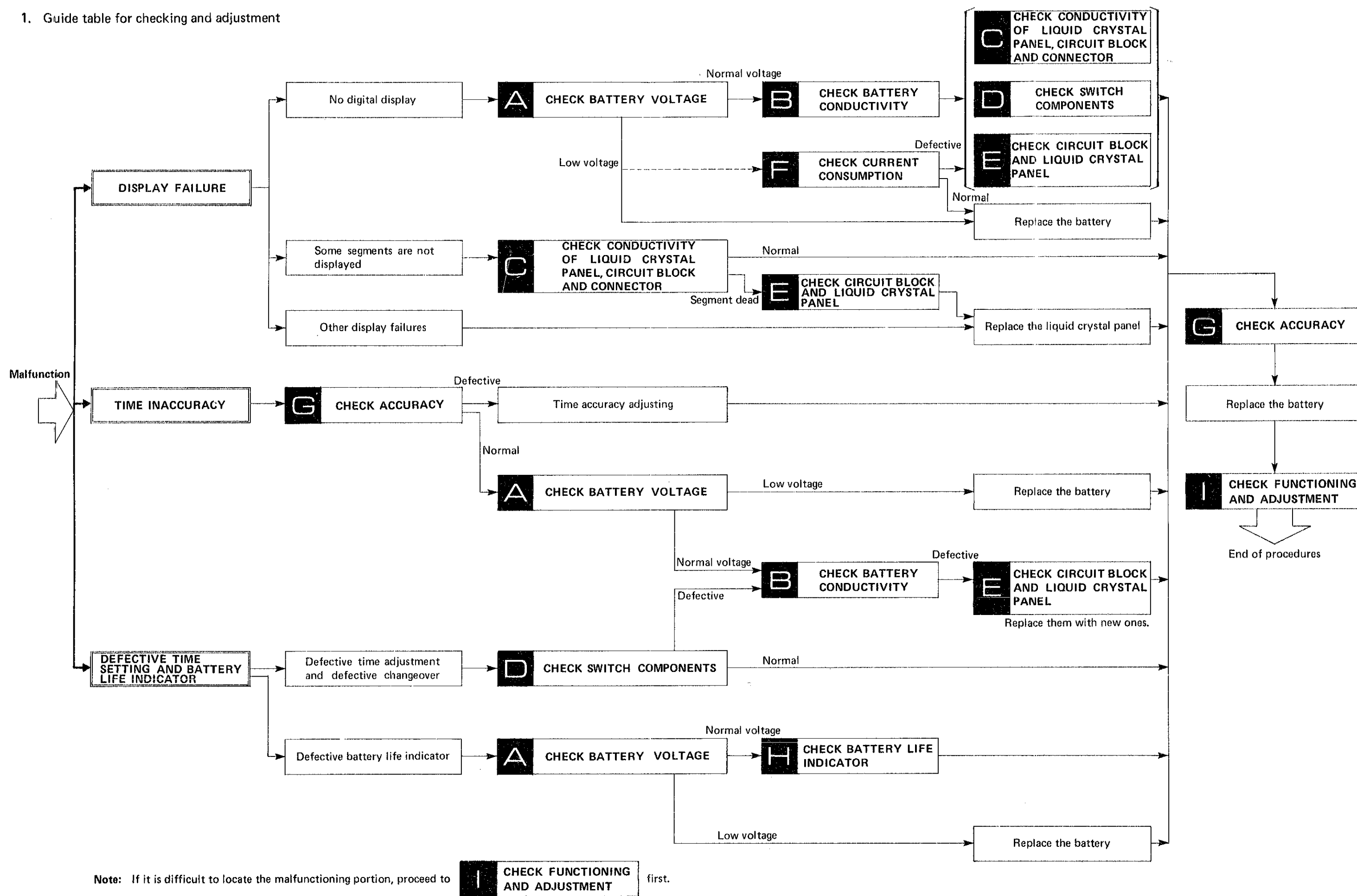

### 1. Guide table for checking and adjustment

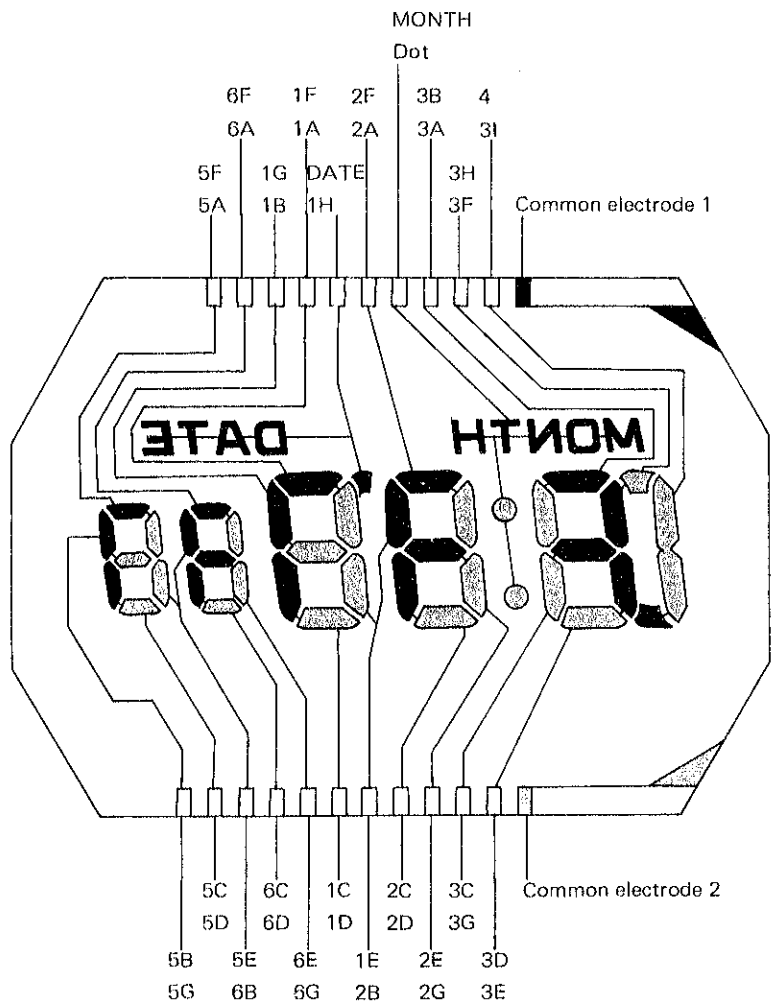



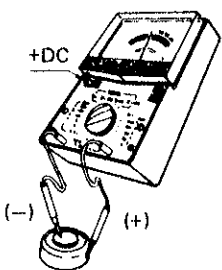
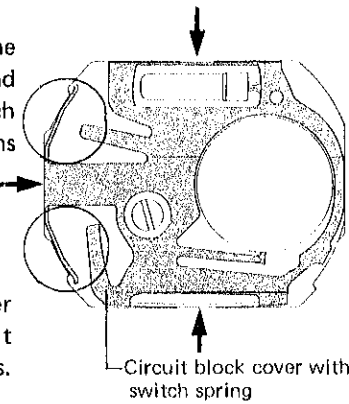

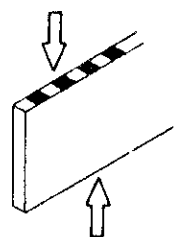
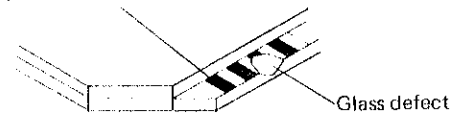
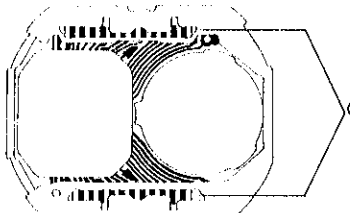
## 2. Procedures for checking and adjustment

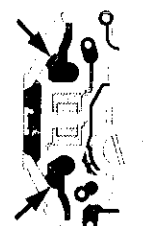
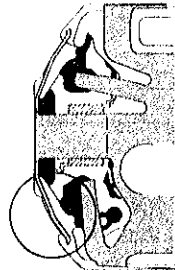
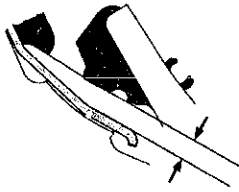
	Procedures	Results and repair
<b>A</b> <b>CHECK BATTERY VOLTAGE</b>	<p>Check battery voltage.</p> <ul style="list-style-type: none"> <li>Set up the volt-ohm-meter. Range to be used: DC 3V</li> <li>Measuring Probe Red (+) ... Battery surface (+) Probe Black (-) ... Battery surface (-)</li> </ul> 	<p>More than 1.5V: Normal Less than 1.5V: Defective Replace the battery with a new one.</p>
<b>B</b> <b>CHECK BATTERY CONDUCTIVITY</b>	<p><b>First check</b></p> <p>Check for any contamination on the battery, the battery connection and the circuit block cover with switch spring, particularly at the portions marked with the circles.</p> <p><b>Second check</b></p> <p>Check to see if the circuit block cover with switch spring is set to the circuit block at the arrow-marked portions.</p> <p><b>Third check</b></p> <p>Check to see if there is battery electrolyte leakage.</p> <p>○ How to repair battery electrolyte leakage</p> <ol style="list-style-type: none"> <li>Remove the module from the case.</li> <li>Disassemble the module.</li> <li>Clean the parts contaminated with battery electrolyte.</li> </ol> <ul style="list-style-type: none"> <li>Clean the circuit block. (1) Wipe off battery electrolyte on the circuit block with a cloth moistened with distilled water (or tap water) first and then with a cloth moistened with alcohol.</li> </ul> <p><b>Note:</b></p> <ul style="list-style-type: none"> <li>Do not use a cloth which gives off lint such as gauze, flannel, etc.</li> <li>Be careful that the trimmer condenser is not exposed to water or alcohol.</li> </ul> <p>(2) Dry with cool air by using a dryer.</p> <ul style="list-style-type: none"> <li>Clean the other parts.</li> </ul> <p>(1) Wipe off battery electrolyte on the other parts with a soft brush moistened with distilled water (or tap water). (2) Dry with cool air by using a dryer.</p> <p>4. Reassemble the module and replace the battery with a new one.</p> <p>5. Check to see if the time setting functions and the current consumption are normal.</p> 	<p>Uncontaminated: Normal Contaminated: Defective Wipe off any foreign matter.</p> <p>Set firmly: Normal Not set firmly: Defective Set firmly.</p> <p>No battery electrolyte leakage: Normal Battery electrolyte leakage: Defective Wipe off battery electrolyte by following the repairing procedures.</p>

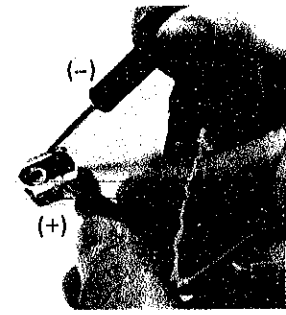
	Procedures	Results and repair
<b>C</b> CHECK CONDUCTIVITY OF LIQUID CRYSTAL PANEL, CIRCUIT BLOCK AND CONNECTOR	<p><b>First check</b> Check for any contamination, crack and tiny break of the connector.</p>  <p>Check carefully the connecting portions with the liquid crystal panel and the circuit block.</p> <p><b>Second check</b> Check the liquid crystal panel electrode (connecting portion with the connector) for any foreign matter and glass defects.</p> <p>Liquid crystal panel electrode</p>  <p>Glass defect</p> <p><b>Third check</b> Check the circuit block electrode (connecting portion with the connector) for any foreign matter.</p>  <p>Circuit block electrode</p>	<p>No contamination, crack or minute break: Normal Contaminated: Defective Wipe off any foreign matter.</p> <p>Cracked or broken: Defective Replace the connector with a new one.</p> <p>No contamination or glass defect: Normal Contaminated: Defective Wipe off any foreign matter.</p> <p>Glass defect: Defective Replace the liquid crystal panel with a new one.</p> <p>Untaminated: Normal Contaminated: Defective Wipe off any foreign matter.</p>
<b>D</b> CHECK SWITCH COMPONENTS	<p><b>First check</b> Check for any contamination on the switch spring of the circuit block cover and the circuit block (connecting portion with the switch spring).</p>   <p><b>Second check</b> Check for clearance between the switch spring and the circuit block. (Check for clearance after the battery guard and the circuit block cover with switch spring are reassembled.)</p>   <p>Check for clearance by looking from above.</p>	<p>Untaminated: Normal Contaminated: Defective Wipe off any foreign matter.</p> <p>Clearance: Normal No clearance: Defective Correct the switch spring with tweezers so that there is a clearance.</p>

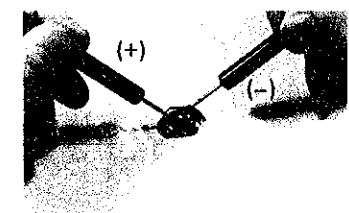
	Procedures	Results and repair
<b>Π</b> CHECK CIRCUIT BLOCK AND LIQUID CRYSTAL PANEL	<p><b>First check</b> Check to see if the electric signal flows into the liquid crystal panel from the circuit block correctly.</p>  <ol style="list-style-type: none"> <li>Set the battery in the module and operate the watch.</li> <li>Disassemble the liquid crystal panel by following the disassembling procedures.</li> <li>Set up the volt-ohm-meter. Range to be used: DC 3V</li> <li>Measuring Probe Red (+): Circuit block cover with switch spring Probe Black (-): Black portions of the connector (Apply the probe to several portions.)</li> </ol> <p><b>Note:</b> Be sure to touch the connector lightly with the probe.</p> <p><b>Second check</b> Check the liquid crystal panel for any broken panel pattern, short circuit, etc.</p> <ol style="list-style-type: none"> <li>Reassemble the liquid crystal panel and the battery.</li> <li>Depress and hold the switch spring (arrow-marked portion) of the circuit block cover with switch spring for 3 to 4 seconds.</li> </ol>  <p>Depress and hold for 3 to 4 seconds.</p>	<p>More than 0.8V: Normal Less than 0.8V: Defective Replace the circuit block with a new one.</p> <p>(The above voltage is obtained when measured with the volt-ohm-meter mentioned in the Technical Guide. When another volt-ohm-meter is used (other than SEIKO), a slightly low voltage may be indicated.)</p> <p>All the segments light up: Normal The connectors and the circuit block are normal, but some segments do not light up: Replace the liquid crystal panel with a new one.</p>
<b>Π</b> CHECK CURRENT CONSUMPTION	<p>Check to see if the current consumption is normal.</p> <ol style="list-style-type: none"> <li>Set up the volt-ohm-meter. Range to be used: DC 12<math>\mu</math>A</li> <li>Probe Red (+) ... Battery connection Probe Black (-) ... Battery surface (-)</li> </ol> 	<p>Less than 2.3<math>\mu</math>A: Normal More than 2.3<math>\mu</math>A: Defective Proceed to <b>C</b>, <b>D</b> and <b>E</b>.</p>

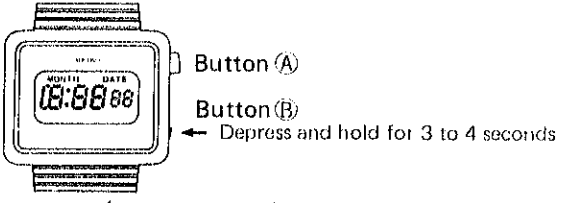
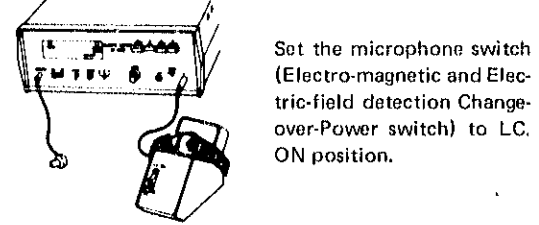
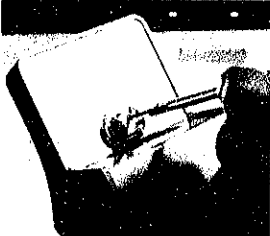
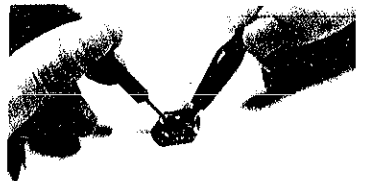
	Procedures	Results and repair
CHECK ACCURACY	<p><b>G</b></p> <p>Check gain and loss of time. As a special circuit is provided in Cal. L221A, measure time accuracy with all the segments displayed.</p> <p>(1) Depress and hold button (B) for 3 to 4 seconds to display all the segments.</p>  <p>(2) Measuring</p>  <p>Set the microphone switch (Electro-magnetic and Electric-field detection Change-over-Power switch) to LC. ON position.</p> <p>• <b>How to adjust time accuracy</b> The watch will gain or lose according to the direction in which the trimmer condenser is turned.</p>  <p>• When the adjustment is completed, depress either button (A) or button (B) to display time digits.</p>	
CHECK BATTERY LIFE INDICATOR	<p><b>I</b></p> <p>Check to see if the battery life indicator functions correctly.</p> <p><b>First check</b></p> <p>(1) Set up the Micro Test. Set the voltage at 1.35V.</p> <p>(2) Remove the battery from the module and apply the terminals of the Micro Test to the module. Red Clip (+) ... Circuit block cover with switch spring Black Probe (-) ... Battery connection</p>  <p><b>Second check</b></p> <p>(1) Set up the Micro Test. Set the voltage at 1.55V.</p> <p>(2) Apply the terminals of the Micro Test to the module in the same manner as in (2) of First check.</p>	<p>Display flashes: Normal Display does not flash: Defective Replace the circuit block with a new one.</p> <p>Display does not flash: Normal Display flashes: Defective Replace the circuit block with a new one.</p>

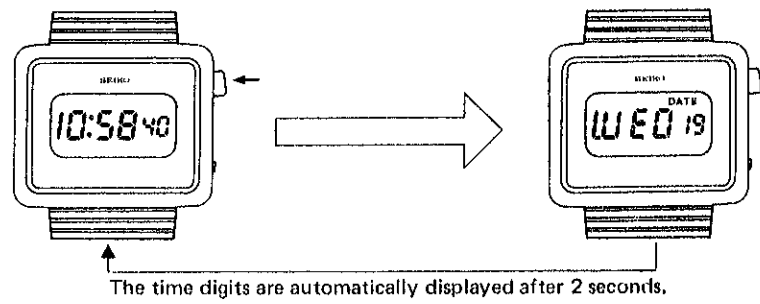
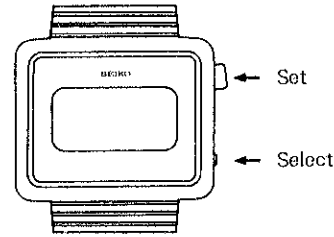
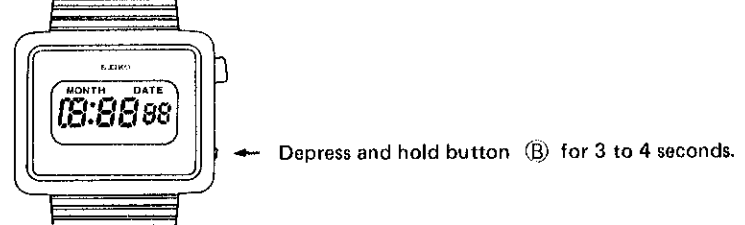
	Procedures
CHECK FUNCTIONING AND ADJUSTMENT	<p><b>J</b></p> <p>Check to see if display changeover and adjustment function correctly by button operation.</p> <p><b>First check</b> Check to see if the time display and the calendar display are changed into the desired display by depressing button (A).</p>  <p>The time digits are automatically displayed after 2 seconds.</p> <p><b>Second check</b> Check to see if each digit is selected and set by depressing buttons (A) and (B).</p>  <p><b>Third check</b></p> <p>(1) Depress and hold button (B) for 3 to 4 seconds and check to see if all the segments are displayed. (Check to see if there are any segments which do not light up.)</p>  <p>(2) Check to see if all the segments are reset to the time display by depressing either button (A) or button (B).</p> 