

# TECHNICAL GUIDE AND PARTS LIST

CAL. Y735A

## DIGITAL QUARTZ

### CONTENTS

I. SPECIFICATIONS .....	1
II. CIRCUIT BLOCK SCHEMATIC .....	1
III. DISPLAY FUNCTION .....	2
IV. DISASSEMBLING, REASSEMBLING AND LUBRICATING .....	3
1. Disassembling, reassembling and lubricating of the case .....	3
2. Disassembling and reassembling of the module .....	5
3. Cleaning .....	6
V. CHECKING AND ADJUSTMENT .....	7
1. Guide table for checking and adjustment .....	7
2. Relationship between the segments (Liquid Crystal Panel electrodes) and C-MOS-LSI output terminals .....	8
3. Procedure for checking and adjustment .....	9
A. Check battery voltage .....	9
B. Check battery conductivity .....	9
C. Check current consumption .....	10
D. Check water resistance .....	11
E. Check contact between C-MOS-LSI ~ Liquid Crystal Panel .....	11
F. Check liquid crystal panel and circuit block .....	12
G. Check accuracy .....	13
H. Check functioning and adjustment .....	13
I. Check conductivity of switch components .....	13
J. Check bulb condition .....	14
K. Check alarm function .....	14
L. Check key input operation .....	15
VI. PARTS LIST .....	16

## I. SPECIFICATIONS

Item	Cal. No.	Y735A
Display medium		Nematic liquid crystal, FEM (Field Effect Mode)
Liquid crystal driving system		Multiplex driving system
Display system		<ul style="list-style-type: none"> <li>• Time and calendar display (12 or 24 hour indication)</li> <li>• Calculator function</li> <li>• Alarm function</li> <li>• Numerical memory function</li> <li>• Stopwatch function</li> </ul>
Additional mechanism		<ul style="list-style-type: none"> <li>• Alarm test system</li> <li>• Hourly time signal</li> <li>• Pattern segment checking system</li> <li>• Automatic return system</li> <li>• Illuminating light</li> </ul>
Loss/gain		Loss/gain at normal temperature range Monthly rate: less than 15 seconds
Casing diameter		25.0mm (between 3 o'clock and 9 o'clock sides) 26.5mm (between 6 o'clock and 12 o'clock sides)
Height		5.2mm
Regulation system		Trimmer condenser
Measuring gate by quartz tester		Any gate is available
Battery		Lithium battery SANYO CR2016, Maxell CR2013 and Matsushita BR2016 Voltage: 3.0V Battery life: Approx. 3 years

## II. CIRCUIT BLOCK SCHEMATIC

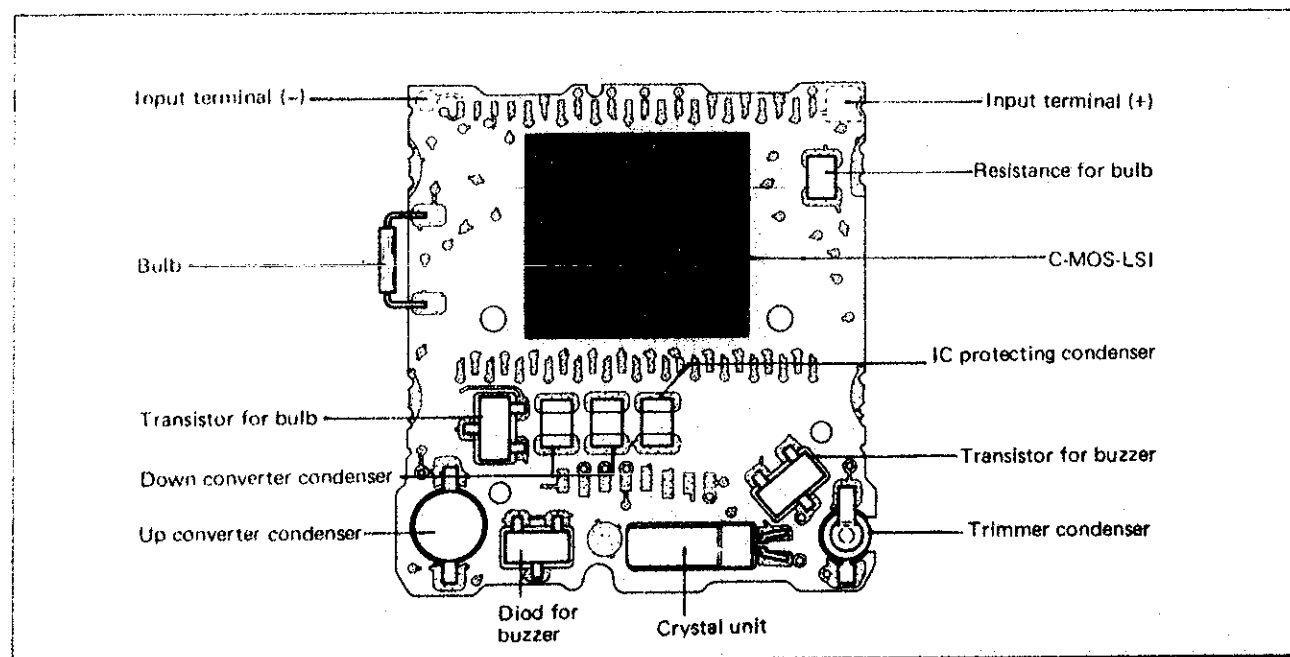

## III. DISPLAY FUNCTION

By each depression of button "A", the function changes in the following order.

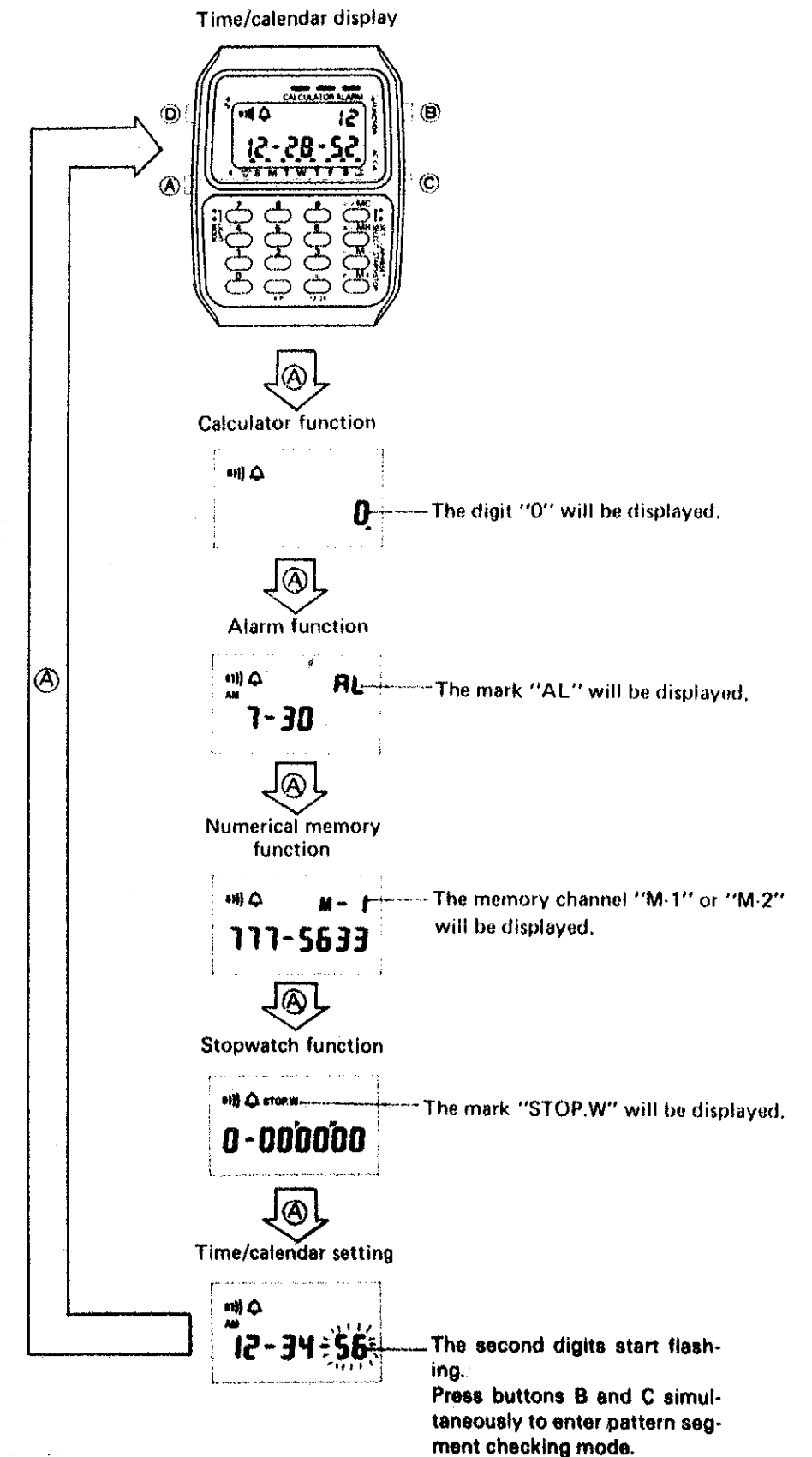

## IV. DISASSEMBLING, REASSEMBLING AND LUBRICATING

### 1. Disassembling, reassembling and lubricating of the case

- Disassembling procedures: ① -- ④
- Reassembling procedures: ④ -- ①

#### Lubricating:

- Silicone grease 500,000 c.s.

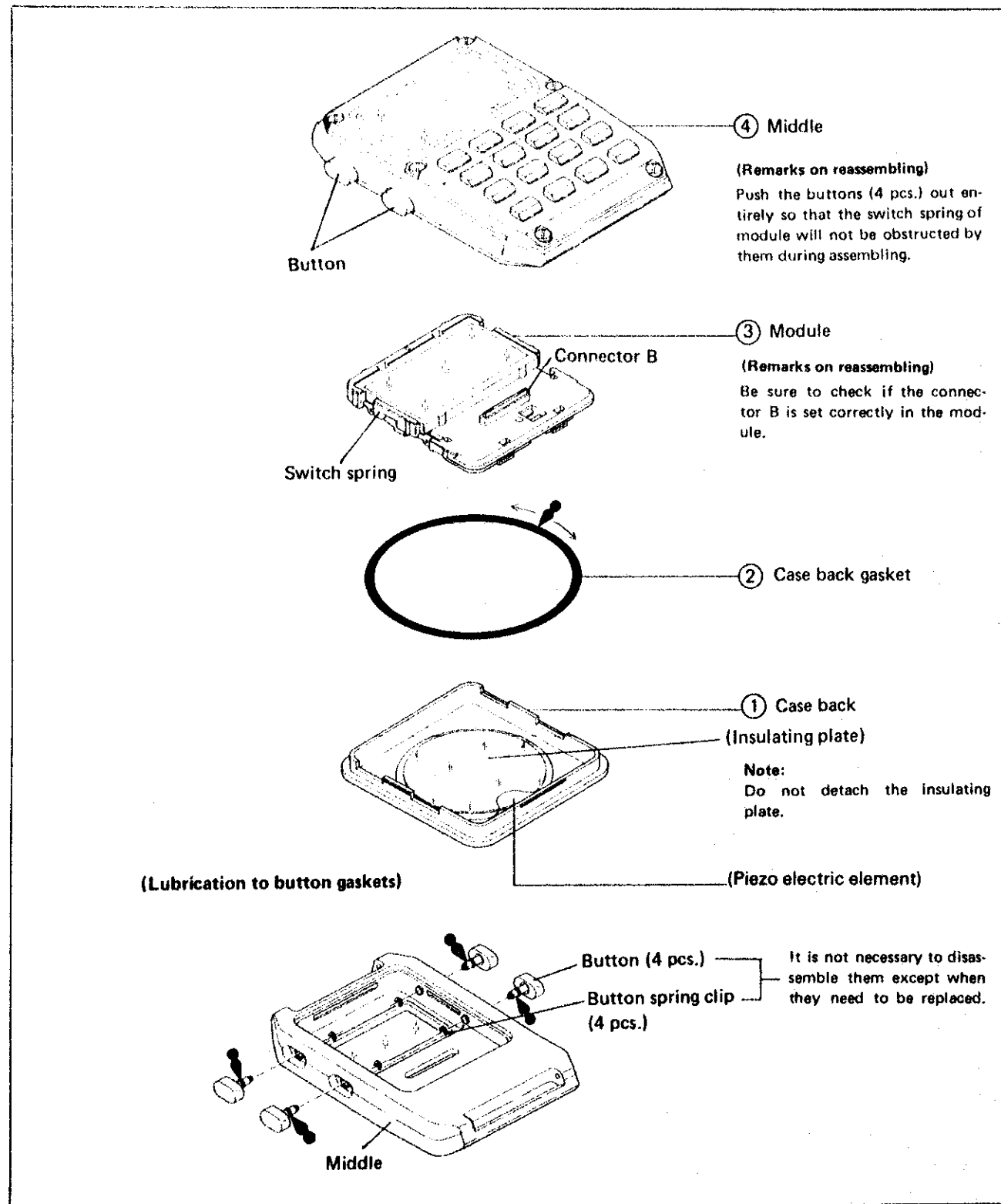

### [ Reassembling of key board portion ]

It is not necessary to disassemble except for replacement.

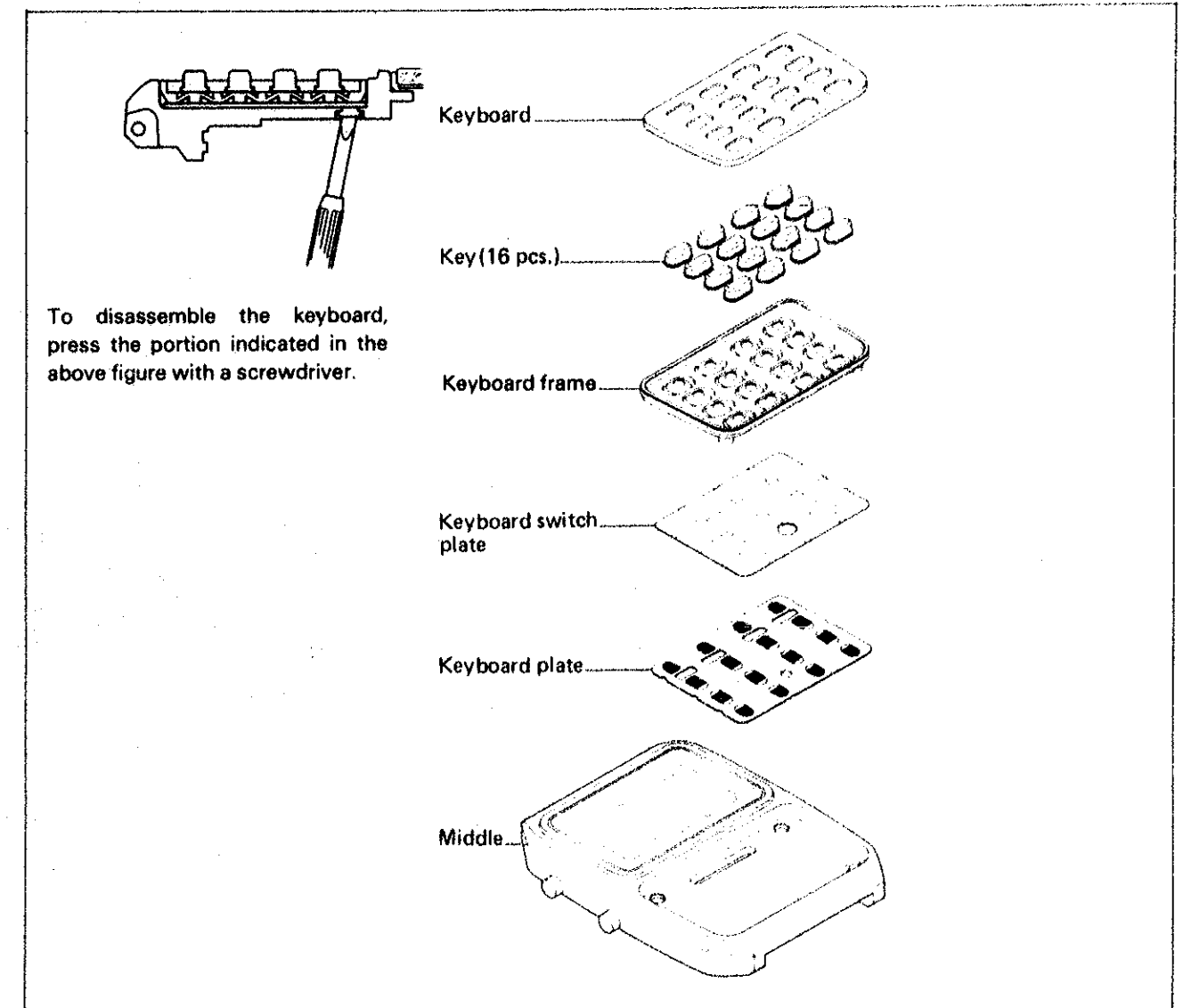

### Assembling the keyboard

- (1) Mount the key buttons (16 pcs) in the keyboard.
- (2) Install the keyboard frame.
- (3) When installing the keyboard in the middle, place another keyboard onto the keyboard to release the key buttons and press them straight with a flat surface jig until the middle is aligned with the keyboard.

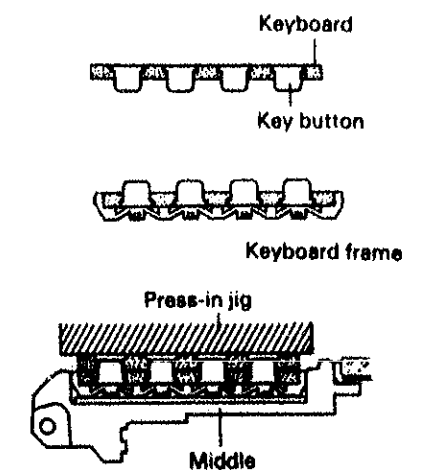

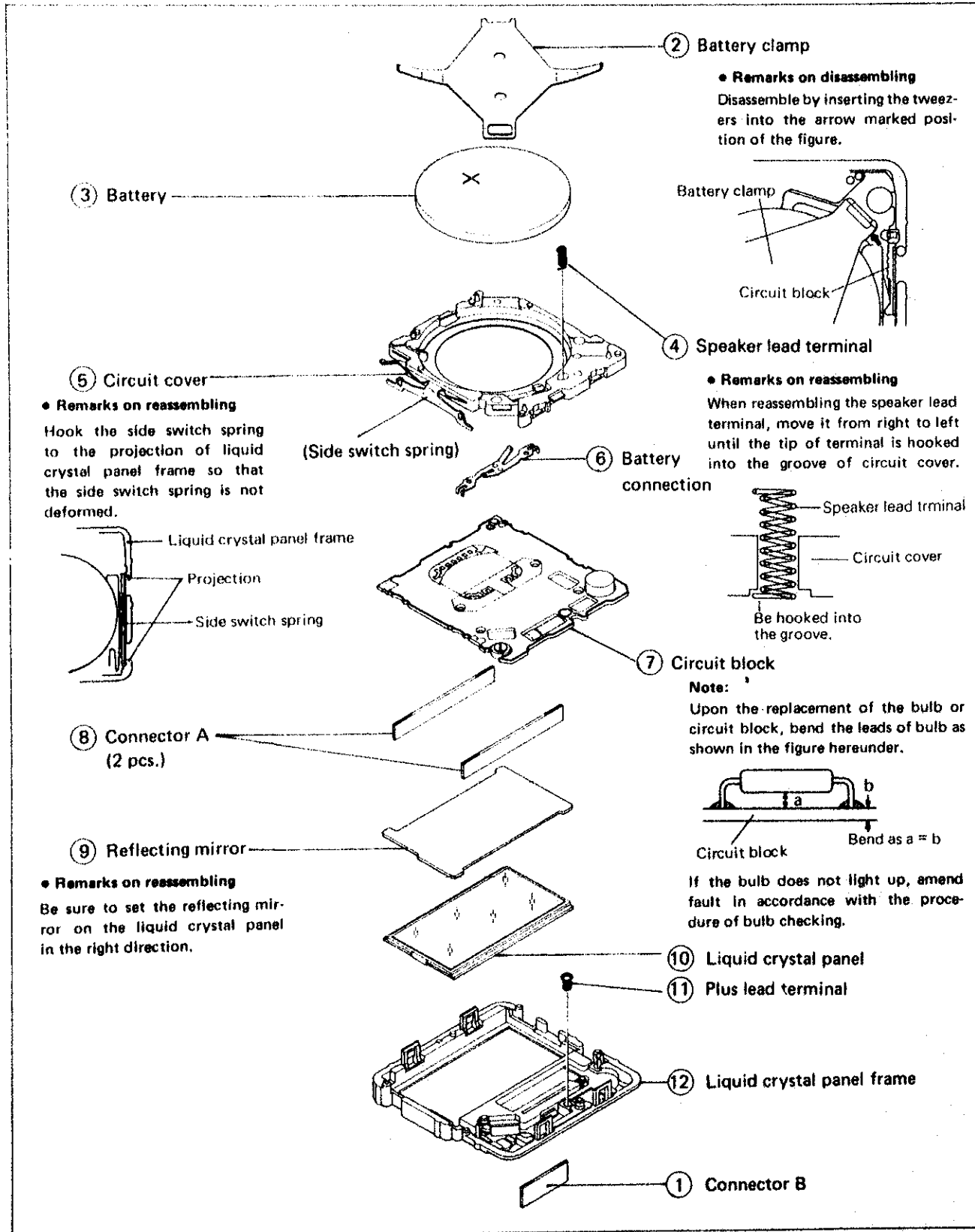

## 2. Disassembling and reassembling of the module

- Disassembling procedures: ① - ⑫ (Remove connector B first.)
- Reassembling procedures: ⑫ - ① (Reassemble the connector B last.)

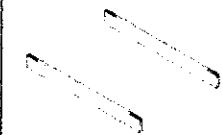

## 3. Cleaning

Name of parts	Cleaning	Drying	Solution	Remarks
Connector 	Rinse or wash with a soft brush.	Warm air	Alcohol	<ul style="list-style-type: none"> <li>• Clean the contacting portion between the connector and liquid crystal panel, and circuit block.</li> <li>• Never use benzene or trichloroethylene as these will dissolve the parts.</li> <li>• Do not set the connector until it is completely dry.</li> </ul>
Plastic parts • Panel frame  • Circuit cover	Rinse or wash with a soft brush.	Warm air	Alcohol or benzene	
Metal parts • Battery clamp	Rinse or wash with a cleaner or wash with a soft brush.	Warm or hot air	Alcohol, benzene or trichloroethylene	

### ☆ Parts that must not be cleaned

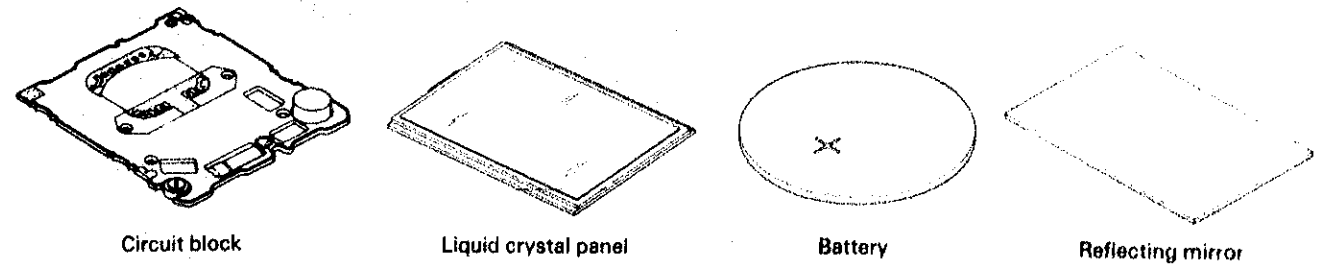

- Only the conductive portions (liquid crystal panel and circuit block etc.) should be wiped with a cloth moistened with benzene and dried with warm air.
- Remove dust and lint with a brush.
- Be careful not to scratch the front surface of the reflecting mirror.

# V. CHECKING AND ADJUSTMENT

## 1. Guide table for checking and adjustment

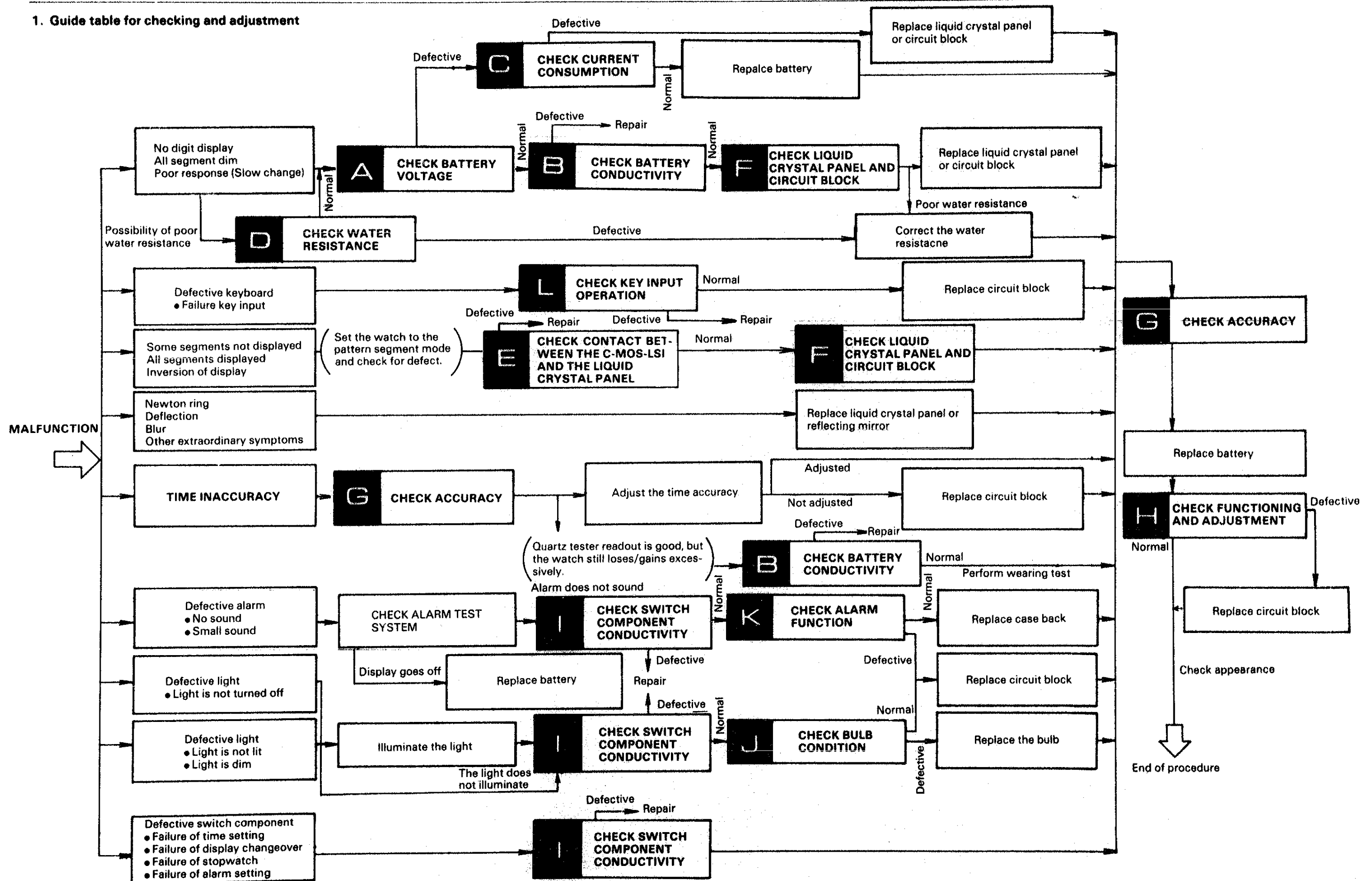

**2. Relationship between the segments (liquid crystal panel electrodes) and the C-MOS-LSI output terminal**

• Designation of segment

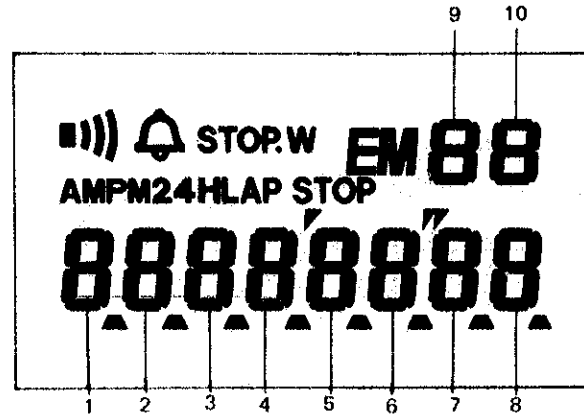
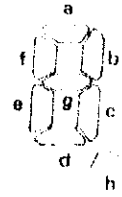

• Relationship between the segment and the C-MOS-LSI output terminal

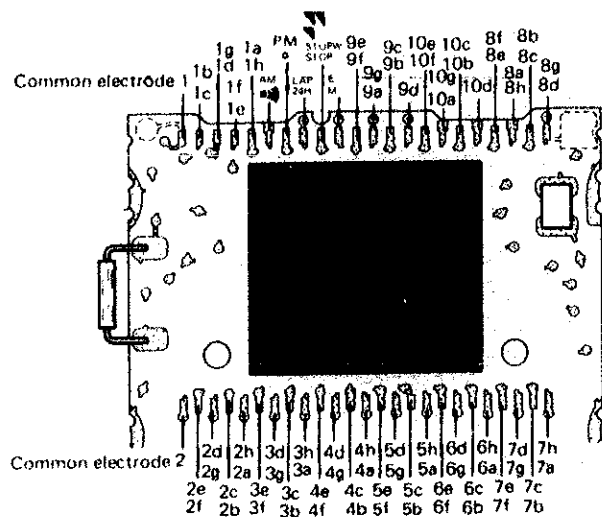
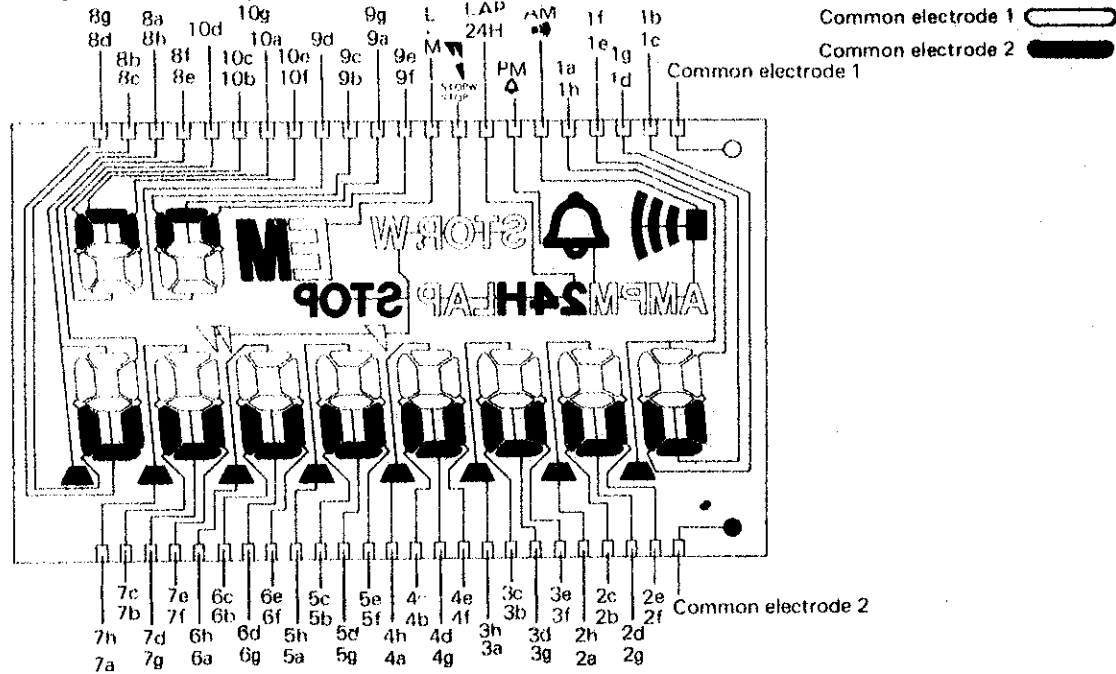

**3. Procedure for checking and adjustment**

	Procedure	Result and repair
CHECK BATTERY VOLTAGE	<p><b>A</b></p> <p>Check that the battery voltage is normal.</p> <p>(1) Set up the Volt-ohm-meter. Range to be used: DC 3V</p> <p>(2) Checking Red probe (+)... Battery surface (+) Black probe (-)... Battery surface (-)</p>	<p>2.8V or more: Normal Less than 2.8V: Defective</p> <p><b>NOTE:</b> If the alarm or lamp is operated before measuring the battery voltage, the voltage temporarily drops to 2.8 V or less. At that time, leave the battery for a few minutes, then check the battery voltage.</p>
CHECK BATTERY CONDUCTIVITY	<p><b>B</b></p> <p>Check the battery, battery clamp and battery connection (-) for contamination.</p>	<p>Uncontaminated: Normal Proceed to <b>C</b> Contaminated: Defective Clean Poor water resistance is found: Correct water resistance.</p>

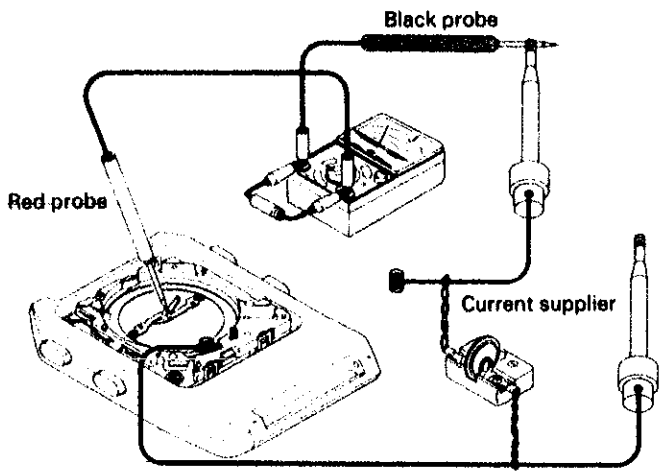
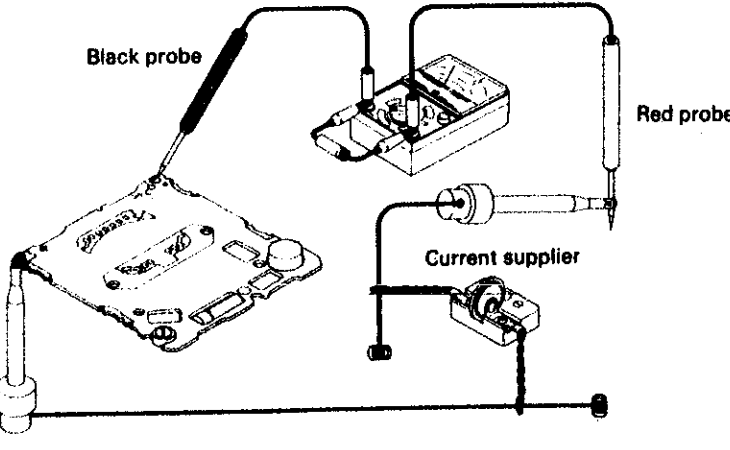
Procedure	Result and repair
<p>(1) Current consumption of the whole of module.</p> <ul style="list-style-type: none"> <li>● Set up the Volt-ohm-meter ranging to be used of DC 12 <math>\mu</math>A.</li> <li>● Check in any function except calculator function.</li> <li>● Set the condenser kit of 200 ~ 500 <math>\mu</math>F.</li> </ul>  <p>*When measuring the current consumption, take care not to allow the incandescent lamp light to emit to the module and circuit block. If the module and circuit block is lit, the measured value tends to become larger.</p>	<p>Less than 1.3 <math>\mu</math>A: Normal 1.3 <math>\mu</math>A or more: Defective Proceed to (2)</p>
<p>(2) Current consumption of circuit block alone.</p> 	<p>Less than 1.2 <math>\mu</math>A: Normal Replace liquid crystal panel. 1.2 <math>\mu</math>A or more: Defective Replace circuit block.</p>

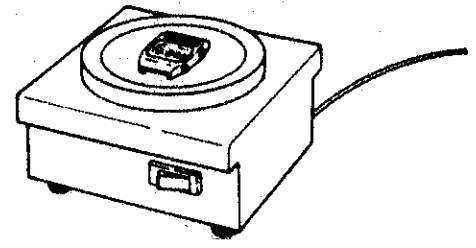
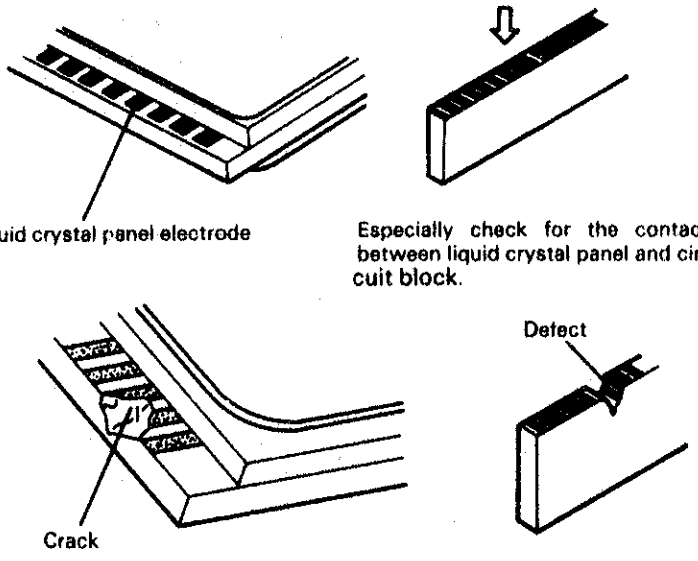
Procedure	Result and repair
<p>Check for moisture in the watch.</p> <p>(1) Place the watch on a hot plate and heat it for 15 minutes.</p>  <p>(2) Check that the glass does not collect moisture.</p>	<p>Does not collect moisture: Normal Collects moisture: Defective Correct water resistance. Refer to "Watch Case Servicing Guide".</p>
<p>Check for dust, lint other contamination of the liquid crystal panel electrodes and connectors. Check the liquid crystal panel and connector for scratches, cracks or defects.</p>  <p>Especially check for the contact between liquid crystal panel and circuit block.</p>	<p>Uncontaminated: Normal Contaminated: Defective Wipe off any foreign matter.</p>

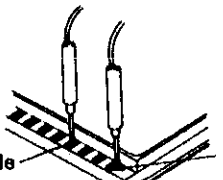
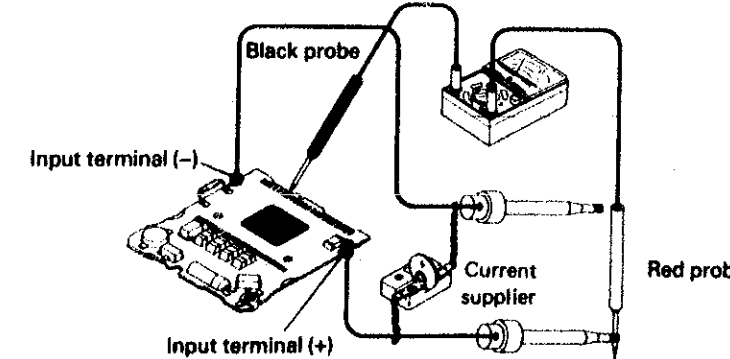
Procedure	Result and repair
<p>● Check that the liquid crystal panel and circuit block function correctly. (Refer to "Relationship between the segments (Liquid Crystal Panel electrodes) and C-MOS-LSI output terminals" on page 8)</p> <p>(1) Checking the liquid crystal panel</p> <p>① Set up the Volt-ohm-meter. Range to be used: OHMS R × 1 ~ R × 1K</p> <div style="border: 1px solid black; padding: 5px; margin: 10px 0;"> <p><b>NOTE:</b> Any range will do if more than 3V is applied to the terminal of the Volt-ohm-meter. In some Volt-ohm-meters, a voltage of more than 3V cannot be applied to the terminal. In this case, all segments are not displayed. Use a higher resistance range (R × 10K).</p> </div> <p>② Remove the liquid crystal panel from the module and turn it to the reverse side.</p> <p>③ Check that the corresponding segment is displayed.</p> <div style="border: 1px solid black; padding: 5px; margin: 10px 0;"> <p><b>NOTE:</b> Either red or black probe will do.</p> </div> <div style="text-align: center; margin: 10px 0;">  <p>Segment electrode      Common electrode (Either red or black probe must be applied to the common electrode.)</p> </div> <p>(2) Checking the circuit block output</p> <p>① Set up the Volt-ohm-meter. Range to be used: DC 3V</p> <p>② Set up the circuit block. Disassemble the module and remove the circuit block.</p> <div style="text-align: center; margin: 10px 0;">  </div>	<p>Displayed: Normal Not displayed: Defective Replace the liquid crystal panel.</p>

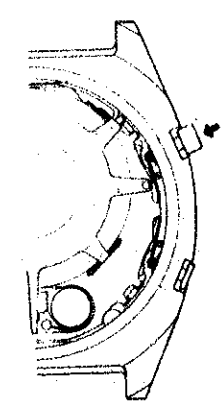
	Procedure	Result and repair
CHECK LIQUID CRYSTAL PANEL AND CIRCUIT BLOCK	<p>(3) Checking Red probe (+): Circuit block (+) terminal Black probe (-): C-MOS-LSI output terminal (If a segment is defective, connect the black probe to the corresponding electrode.)</p>	<p>0.8V or more: Normal (The voltage at all terminals should be more than 0.8V.) Less than 0.8V: Defective Replace the circuit block.</p>
CHECK ACCURACY	<p>Any measuring gate can be used. Check accuracy in the pattern segment checking mode.</p> <p>● Pattern segment checking mode Set the watch to the time setting mode and press buttons B and C simultaneously to obtain the pattern segment checking mode.</p>	<p>Does not loss or gain: Normal Losses or gains: Defective Replace the circuit block</p>
CHECK FUNCTIONING AND ADJUSTMENT	<p>Check functioning referring to "DISPLAY FUNCTION" on page 2.</p> <p>(1) Check that the time mode and alarm mode are changed correctly. (2) Perform alarm test and check that the alarm sounds correctly and alarm mark and time signal mark are displayed correctly. (3) Check the functioning for each digit in the time and calendar modes and confirm that the digit is advanced correctly.</p>	<p>Functions correctly: Normal Wear the watch on the wrist to check time accuracy. Does not function correctly: Defective Replace the circuit block.</p>
CHECK CONDUCTIVITY OF SWITCH COMPONENT	<p>(1) Check that the switch spring functions correctly.</p> <div style="text-align: center; margin: 10px 0;">  </div> <p>(2) Check for dust, lint and other contamination of the connecting portions.</p>	<p>Functions Correctly: Normal Does not function correctly: Defective Correct the switch spring with tweezers or replace the circuit cover with a new one.</p> <p>Uncontaminated: Normal Contaminated: Defective Wipe off any foreign matter.</p>

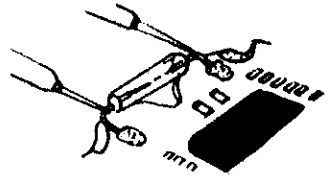
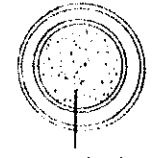
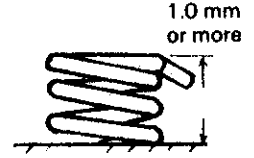
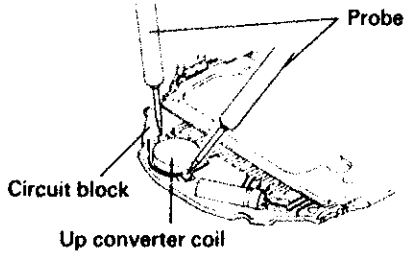

	Procedure	Result and repair
CHECK BULB CONDITION	<p>Check that there is a broken filament in the bulb.</p> <ol style="list-style-type: none"> <li>Set up the Volt-ohm-meter. Range to be used: OHMS R x 1</li> <li>Checking Apply two probes of the Volt-ohm-meter to the bulb leads as shown in the illustration.</li> </ol> <div style="border: 1px solid black; padding: 2px; width: fit-content; margin: 10px auto;"> <p>Either red or black probe will do.</p> </div> 	<p>Bulb lights up: Normal Bulb does not light up: Defective Replace the bulb with a new one.</p>
CHECK ALARM FUNCTION	<ol style="list-style-type: none"> <li>Check the contacting portion of the piezo electric element on the case back and speaker lead terminal and check the speaker lead terminal for deformation. <div style="text-align: center;">  <p>Piezo electric element</p> </div> <div style="border: 1px solid black; padding: 5px; margin: 10px 0;"> <p><b>NOTE:</b> The speaker lead terminal should be protruded from the circuit cover by 1.0 mm or more. (Check when the speaker lead terminal is completely installed.)</p> </div> <div style="text-align: center;">  <p>1.0 mm or more Circuit cover</p> </div> </li> <li>Measure the coil resistance of the circuit block to check for a short-circuit and a broken wire. Range to be used: OHMS R x 1 <ul style="list-style-type: none"> <li>Checking Apply the probes to the up converter coil terminals. Either red or black probe will do.</li> </ul> <div style="text-align: center;">  <p>Probe Circuit block Up converter coil</p> </div> </li> </ol>	<p>Uncontaminated: Normal Contaminated: Defective Wipe off any foreign matter. Deformed: Defective Correct with tweezers.</p> <p>50Ω - 90Ω: Normal Less than 50Ω: (Short-circuit) More than 90Ω: Defective (Broken wire) Replace the circuit block with a new one.</p>

	Procedure	Result and repair
CHECK KEY INPUT OPERATION	<ol style="list-style-type: none"> <li>Check dust and contamination between the keyboard and key buttons. (Check by operating the button.)</li> <li>Check dust and contamination between connector B and keyboard switch plate and circuit block.</li> </ol>	<p>Does not function correctly: Defective Correct and check again. Functions correctly: Normal Replace the circuit block. If the problem still persists, replace the keyboard switch plate.</p>
HOW TO CHECK FOR BATTERY ELECTROLYTE LEAKAGE AND REPAIR	<ol style="list-style-type: none"> <li>Remove the module from the case.</li> <li>Disassemble the module.</li> <li>Wipe off any electrolyte from the circuit block. <ol style="list-style-type: none"> <li>Wipe off the electrolyte with cloth moistened with alcohol. (Pay particular attention to the connecting portion.)</li> <li>Dry with warm air by using a dryer.</li> </ol> <div style="border: 1px solid black; padding: 5px; margin: 10px 0;"> <p><b>NOTE:</b> ● If the electrolyte leakage is excessive, replace the circuit block. ● Use a lint-free cloth.</p> </div> </li> <li>Clean other parts (Circuit cover and liquid crystal panel frame) which become contaminated with the electrolyte. <ol style="list-style-type: none"> <li>Wipe off battery electrolyte on the other parts with a soft brush moistened with alcohol.</li> <li>Dry with warm air by using a dryer.</li> </ol> <div style="border: 1px solid black; padding: 5px; margin: 10px 0;"> <p><b>NOTE:</b> ● If each part is damaged, replace it with a new one.</p> </div> </li> <li>Reassemble the module. Replace the battery with a new one.</li> <li>Check functioning and current consumption.</li> </ol>	

## VI. PARTS LIST

PART NO.	PART NAME
4001 830	Circuit block
4224 832	Keyboard plate
4225 832	Battery clamp
4246 858	Lead terminal (+)
4246 859	Speaker lead terminal
4270 795	Battery connection (-)
4293 832	Keyboard switch plate
4313 830	Connector (A)
4313 831	Connector (B)
4398 830	Panel frame
4410 830	Circuit cover
*4510 825	Liquid crystal panel
*4510 826	Liquid crystal panel
4521 890	Reflecting mirror
4530 230	Bulb
MAXELL CR2016 MATSUSHITA BR2016 SANYO CR2016	} Lithium battery

### Remarks:

Liquid crystal panel

\*4510 825 (Silver)

\*4510 826 (Gold)

The type of liquid crystal panel is determined based on the design of case.